

2022



OUR BRANDS MAKE A DIFFERENCE





THE NEWEST BRAND TO JOIN THE PAR AIDE FAMILY

Miltona joins the industry-leading family of Par Aide brands that includes Accuform, HiO, FusionCast and FusionCore. The addition of Miltona further solidifies Par Aide as THE source for accessory and turf/maintenance tools that offer time-saving, course-improving products designed to help you achieve superior course conditions and improve overall course playability. We've incorporated the full line of Miltona products throughout the Par Aide catalog and website, and these products are now available via all Par Aide distributors.

TEE PRODUCTS

Ball Washers & Parts 7-11, 48
 Ball Washer Detergents 12
NEW Towels 12
 Benches 13, 49
 Trash Receptacles 14, 44, 50
 Divot Mix Containers 16, 45, 50
 Spike & Shoe Cleaners 18
 Club Washers 19, 43, 53
NEW Cube Tee Marker 20
 Tee Markers 20-23

GREENS PRODUCTS

Flagsticks & Parts 25-29
 Quick Release Top Stud 27
 Vinyl-Covered Flagsticks 28
 PinSite® Reflector 29
 Prism Flagsticks 29
 Putting Cups 30
 Foam Cup Riser 31
 Edge-Saver™ 32
NEW Golf Hole Ring 32
NEW Golf Hole Ring Cup Setter 32
 Big Cup Golf 33
 Custom Logo Flags 33
 Regulation Flags 34
 Practice Green Flags 35
 Specialty Flags 35

PRACTICE AREA

Wood Practice Green Markers 37
 Practice Green Marker Flag Sets 38
 Rolling Ball Picker 40
 Sure Putt™ Practice Green System 40
 Practice Range Signs 41
 Proximity Markers 41

RECYCLED PLASTIC

The Woods Collection

Range Crate 43
 Range Pro™ – Club Washing Unit 43
 Trash Pro™ – Trash Receptacles 44
 Clock & Clock Pro™ 45
 Divot Pro Jr.™ – Divot Mix Container 45
 Igloo® Water Coolers 46
 Water Pro™ – Water Stations 46
 Cooler Pro™ – Ice Chest 47
 Range Ball Storage Box 47
 Broken Tee Box 48
 Scorecard Caddy 48
 Tee Pro™ – Ball Washer 48

RECYCLED PLASTIC

The Superior Collection

NEW Benches 49
NEW Divot Mix Containers 50
NEW Trash Receptacles 50
NEW Bag Stands 52
NEW Broken Tee Box 52
NEW Club Washers 53
NEW Range Tee Dividers 53
NEW Sand Divot Bottle Box 54
NEW Starter Podium 54
NEW Water Cooler Tower 55
 Safe-Tee Water™ System 55

COURSE MARKINGS

FusionCast® Course Signage 57
NEW FusionCore™ Course Signage 64
 Dura-Flex™ Signs 67
 Wood Directional Signs 68
 Par 3 Distance Sign 69
 Marking Paint and Applicators 70
 Green & White™ Directional Markers 71
 Hazard & OB Markers 72
 Rope Stakes & Rope 73
 Laminate Fairway Distance Markers 74
 Vinyl-Covered Fairway Poles 74
NEW Cart Directional Barrier 75
NEW Course Access Flags 75
NEW EZ See™ Distance Markers 75

GREENS TOOLS

Original Hole Cutters 77
 HiO® Hole Cutter 78
NEW Center Set Cup Setter 80
NEW Cup Hole Trimming Scissors 80
 Greens Tools 80
 Hole Cutter Mount 81
NEW Miltona Cup Auger™ 81
 Crew Caddy™ 82
 Cup-Saver™ 82
 360° Hole Painter™ 83

ACCUFORM™ BUNKER RAKES

Accuform™ Bunker Rakes 85
 AccuCurv™ Bunker Rakes 87
 Accuform™ Golf Cart Bunker Rakes 88
 Maintenance Rake 88
 ProTect™ Grip 89
 Rake Handles 89

MAINTENANCE TOOLS

Accuform™ Rakes 91
 Accuform™ Maintenance Tools 92
 Accuform™ Star Spiker 93
 Accuform™ Turf Tools 93
 Accuform™ AccuSeed™ 94
 Accuform™ AccuFix™ 95
NEW Miltona Level Best™ 95
NEW Miltona Greens Bullet 96
NEW Miltona Quick-Fill Ball Mark Eraser 96
NEW Miltona Ground Zero II 97
NEW Miltona Quickcut™ Trimmer 97
 Core Hog® – Aeration Cleanup Tool 98
 Cup Plugs 98
 Core Buster™ Drag Mat 99
 Whiteboard System 100
 Padded Work Gloves 101
 Safety Net 101
 E-Z Whipping Pole 102
NEW Dew Draggin' 103
NEW Green Draggin' 103

MILTONA TURF REPAIR TOOLS

NEW Miltona Hex Plugger™ 105
NEW Miltona Turf Pluggers 106
NEW Miltona Sod Stripper™ 107
NEW Miltona Quick Seed™ 108
NEW Miltona Spot Overseeder-Spiker 108
NEW Miltona Jobsaver™ 109
NEW Miltona Plug Stacker™ 110
NEW Miltona Turfjector™ 110
NEW Miltona Aerifier/Soil Sampler 111
NEW Miltona Handi-Aerifier™ 111
NEW Miltona Soil Probe 111
NEW Miltona Soil Profiler 111



MILTONA TURF TOOLS

- Hex and Square Pluggers – Pages 105-106
- Sod Stripper™ – Page 107
- Quick Seed™ – Page 108
- Spot Overseeder-Spiker – Page 108
- Job Saver™ – Page 109
- Plug Stacker™ – Page 110
- Turfjector™ – Page 110
- Aerifiers and Soil Probe – Page 111



RECYCLED PLASTIC

- Benches – Page 49
- Divot Mix Containers – Page 50
- Trash Receptacles – Pages 50-51
- Five Stall Bag Rack – Page 52
- Folding Bag Stands – Page 52
- Club Washers – Page 53
- Range Tee Dividers – Page 53
- Divot Bottle Box – Page 54
- Starter Podium – Page 54
- Water Cooler Tower – Page 55



MAINTENANCE TOOLS

- Maintenance Rake – Page 88
- Greens Bullet – Page 96
- Quick-Fill Ball Mark Eraser – Page 96
- Ground Zero II – Page 97
- QuickCut™ Trimmer – Page 97
- Dew Draggin' & Green Draggin' – Page 103



FusionCore™ & COURSE MARKINGS

- Tee Markers – Page 64
- Course Signage – Page 65
- Tee Signage – Page 65
- Directional Signs – Page 66
- Course Access Flags – Page 75
- EZ See™ Distance Markers – Page 75



TEE PRODUCTS

- Disposable Tee Towels – Page 12
- Cube Tee Marker – Page 20
- Fore-Ever Marked Tee Markers – Page 21



GREENS TOOLS

- Golf Hole Ring – Page 32
- Golf Hole Ring Cup Setter – Page 32
- Center Set Cup Setter – Page 80
- Cup Hole Trimming Scissors – Page 80
- Cup Auger – Page 81
- Level Best™ Ball Mark Repair Tool – Page 95





TEE PRODUCTS



The perfect start, starts here.

The iconic Par Aide Ball Washer is a mark of course excellence. With legendary reliability, durability and low maintenance, proven over 65 years, it's not only the most recognizable ball washer in golf, it's the first thing golfers expect to see at the tee.



DELUXE BALL WASHER

Our most popular model. Drain plug located in front for easy cleaning and flushing. Patented internal overflow sends excess liquid down the inside of the pipe stand.

- Capacity: 7 pt. (3.3 liter)
- 203-01** Par Aide Red
- 203-02** Hunter Green
- 203-00** Black
- 203-99** Other color, please specify

MASTER BALL WASHER

The classic. Original design ensures reliability: durable aluminum castings and just one moving part. Easy to maintain and update, eliminates leakage with tamper-resistant drain plug and gasket.

- Capacity: 5 pt. (2.4 liter)
- 205-01** Par Aide Red
- 205-02** Hunter Green
- 205-00** Black
- 205-99** Other color, please specify

COLOR OPTIONS AVAILABLE

STOCK COLORS



OPTIONAL COLORS (No additional charge)

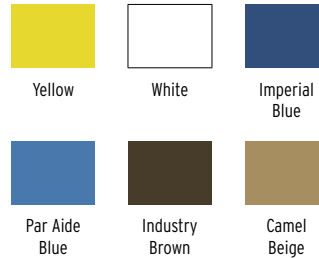

***CUSTOM COLORS AVAILABLE**

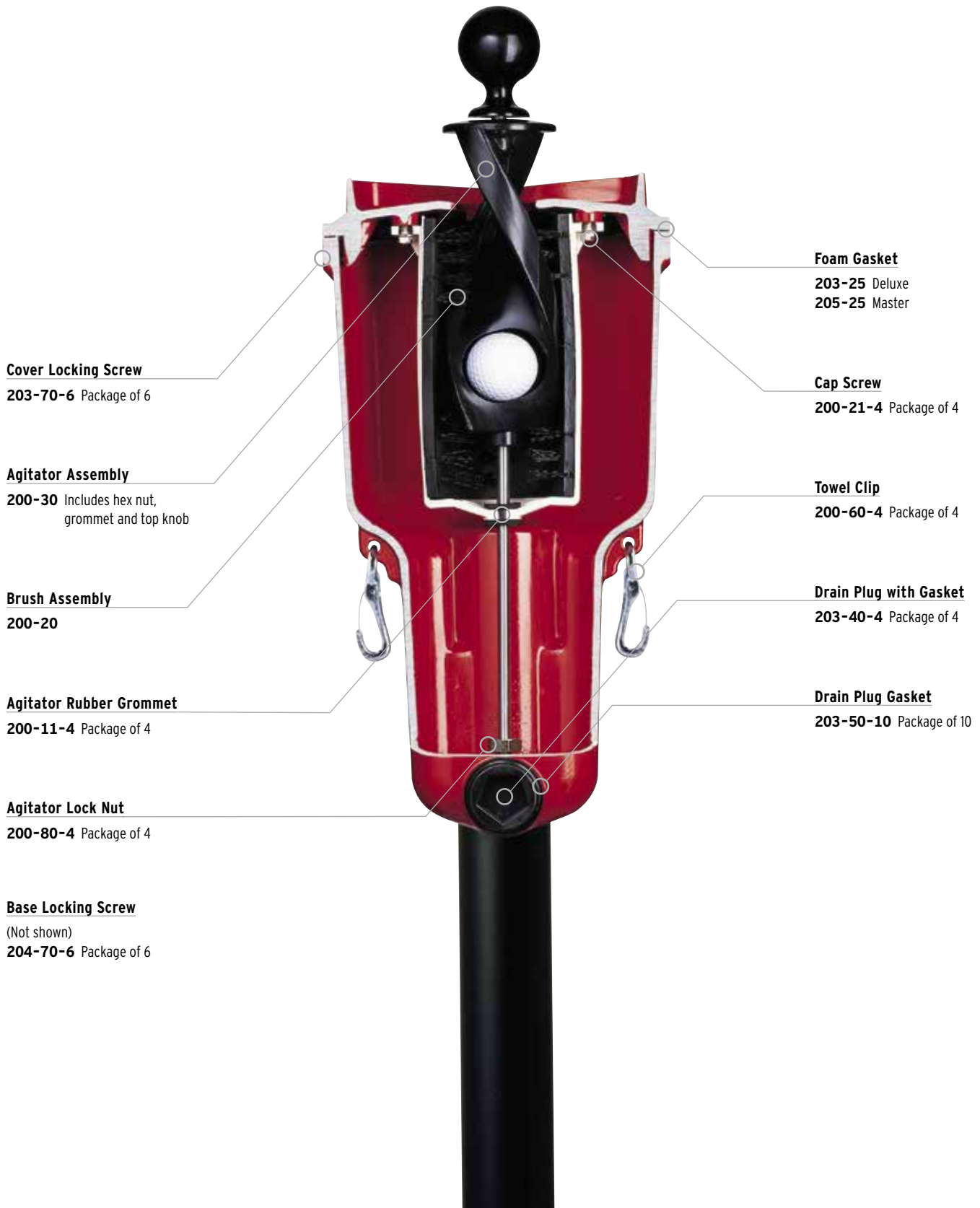



MOUNTING PIPE

Lightweight, no-rust aluminum pipe for your ball washer installation. Powder-coated finish. 2 3/8 in. (6 cm) outside diameter.

34 in. (86 cm) Mounting Pipe

- Use with portable base.
- 210-00** Black
- 210-02** Hunter Green

210-99 Other color, please specify

48 in. (1.2 m) Mounting Pipe

- For permanent in-ground installation.
- 211-00** Black
- 211-02** Hunter Green

211-99 Other color, please specify



PORTABLE BASE

This 18 in. (46 cm) diameter portable base eliminates the need for permanent ball washer installation and gives you unmatched flexibility for relocation of your ball washers as your course evolves. Spikes included for extra stability.

- 310-01** Par Aide Red
- 310-02** Hunter Green
- 310-00** Black
- 310-99** Other color, please specify

321-3 Portable base spike (set of 3) (not shown)



BALL WASHER BRACKET

Powder-coated aluminum bracket used to mount Master and Deluxe Ball Washers to any flat surface 3 in. (8 cm) or wider.

215-00 Black

BALL WASHER REPAIR KIT

Everything you need to refurbish our Master/Deluxe Ball Washer models. Properly maintained ball washers are an easy and affordable way to ensure golfer satisfaction. Always use original Par Aide parts with your ball washers for best performance for years to come.

200-10 Complete Kit



Give players a clean start on every hole.

Par Aide Ensembles let you equip your course intelligently with well-placed, integrated accessories. Pair a Par Aide Ball Washer by attaching double Trash Mate® receptacles after the turn to handle snack bar refuse and recyclables. Attach a Club Washer on your par-3 holes. Or a spike brush. Create the Ensemble unit that fits the unique needs of each hole and your practice area.



Key Feature

Spike brush can be added to any ensemble (see page 18).



MASTER ENSEMBLE

- 50-01 Par Aide Red
- 50-02 Hunter Green
- 50-00 Black
- 50-99 Other color, please specify



MASTER ENSEMBLE WITH TRASH MATE® SINGLE UNIT*

- 51-01 Par Aide Red
 - 51-02 Hunter Green
 - 51-00 Black
 - 51-99 Other color, please specify
- *Trash opening lid included



MASTER ENSEMBLE WITH TRASH MATE® DOUBLE UNIT*

- 52-01 Par Aide Red
 - 52-02 Hunter Green
 - 52-00 Black
 - 52-99 Other color, please specify
- *One trash and one "Cans Only" lid included

Many color options available. See page 7 or go to ParAide.com for more.
Towels are not included with ensembles and may be purchased separately (see page 12).



DELUXE ENSEMBLE

- 30-01 Par Aide Red
- 30-02 Hunter Green
- 30-00 Black
- 30-99 Other color, please specify



DELUXE ENSEMBLE WITH TRASH MATE® SINGLE UNIT*

- 31-01 Par Aide Red
 - 31-02 Hunter Green
 - 31-00 Black
 - 31-99 Other color, please specify
- *Trash opening lid included



DELUXE ENSEMBLE WITH TRASH MATE® DOUBLE UNIT, SPIKE BRUSH AND CLUB WASHER*

- 34-01 Par Aide Red
 - 34-02 Hunter Green
 - 34-00 Black
 - 34-99 Other color, please specify
- *One trash and one "Cans Only" lid included

Key Feature
Washable & Reusable

Par Aide Exclusive
Your only source for black disposable tee towels.



CORNER GROMMET COTTON TEE TOWELS

18 in. x 18 in. (46 cm x 46 cm)

403-2 Hunter Green/dozen

404-2 Hunter Green/case of 12 dozen

TRIFOLD COTTON TEE TOWELS

Large 18 in. x 18 in. (46 cm x 46 cm)

403 Hunter Green/dozen

404 Hunter Green/case of 12 dozen

405 Black/dozen

406 Black/case of 12 dozen

NEW DISPOSABLE TEE TOWELS

- Disposable tee towels available in green or black
- Par Aide exclusive black towels hide dirt and stains
- 21 in. x 16 in. (53 cm x 41 cm) colorfast tee towel
- Durable yet economical
- Sold in cases of 200

642100 Green/case of 200

642110 Black/case of 200



BALL WASHER LIQUID DETERGENT

Lemon-scented and non-sudsing concentrate, formulated with anti-bacterial and odor-control agents. 1 oz. is all that is needed per clean and fill. Won't damage internal parts.

4110 1 gal. (3.7 liter) container

4112 Case of 4 (1 gal. [3.7 liter] containers)

BALL WASHER DETERGENT TABLETS

Lemon-scented, non-sudsing formula. Use one or two tablets with each clean and fill servicing. Tablets provide a long-lasting cleaning solution. Eliminates the need for measuring.

4102 5 lb. carton

4103 Case of 4 (5 lb. cartons)

TOUCH-UP PAINT*

Matches the three Par Aide colors listed below. Adjustable fan spray can for expert results. Sold individually.

1310-00 Black

1310-01 Par Aide Red

1310-02 Hunter Green

*Ground delivery only.



WHITE CEDAR LOG BENCH

Log benches have been used on golf courses since the beginning of the game. The White Cedar Log Bench provides the ultimate in durability while giving your course a distinct, timeless and hand-crafted look. Each bench is uniquely custom-made and comes unfinished.

1475 5 ft. (1.5 m)



PARK BENCH

This 6 ft. (1.8 m) Park Bench is a great value. Heavy-duty formed steel frame, stock finished in Hunter Green powder-coating (other colors available). Premium-grade boards in classic natural finish, or you can purchase the Frame Kit only and use your own wood.

1455-02 6 ft. (1.8 m) Park Bench
with Premium-grade Boards

Frame Kit
No boards, complete with hardware.

1460-02 Hunter Green
1460-99 Other color, please specify

TEAK BENCHES

Our durable teak benches come unfinished and are meant to weather naturally to a silver/gray patina, enhancing the beauty of the wood. These comfortable benches will dress up your course and last for years to come.



TRADITIONAL TEAK BENCH

1480 6 ft. (1.8 m) Unfinished Teak Bench with Back Rest



JUNIOR TEAK BENCH

1486 4 ft. (1.2 m) Unfinished Teak Bench – No Back Rest

See page 49 for additional bench options.

Clean design for a clean course.

A durable Trash Mate® receptacle at every tee box keeps trash off your grounds and out of your carts too. A clean, low-profile design and rugged poly construction offers a long life solution for centralizing your maintenance requirements.

TRASH MATE

- Poly construction impervious to rusting and denting
- Maximum UV protection added to prevent brittleness and fading
- Capacity: 9 gal. (34 liter) also accepts trash bag liners
- Windproof, snap-on lids available in three styles, in Black: solid (no opening) to resist pests, trash opening and "Cans Only" opening
- Convenient attachment to ball washer pipe reduces number of objects to be moved before mowing
- Flexible design allows you to add a second receptacle for recycling
- Stackable/nesting design saves storage space
- Mounting hoops are pre-treated for added protection and then powder-coated
- Go to ParAide.com for Trash Mate mounting options



TRASH MATE CONTAINERS (Sold individually)

- 3014-00 Black
- 3014-01 Red
- 3014-02 Hunter Green
- 3014-03 Blue

*Lids sold separately.



 Now available in blue, the familiar color of recycling bins



TRASH MATE SINGLE UNIT

Comes with one trash opening lid and all necessary mounting hardware.

- 3005-00 Black
- 3005-01 Red
- 3005-02 Hunter Green
- 3005-03 Blue



TRASH MATE DOUBLE UNIT

Includes two lids: "Cans Only" and trash opening and all necessary mounting hardware.

- 3001-00 Black
- 3001-01 Red
- 3001-02 Hunter Green
- 3001-03 Blue



TRASH MATE SINGLE UNIT WITH IN-GROUND TRASH MATE STAND

- 3004-00 Black
- 3004-01 Red
- 3004-02 Hunter Green
- 3004-03 Blue

COMPLETE MOUNTING KIT

Includes Back Clamp, Mounting Bracket, Hoop Frame and Hardware.

- 3019 Complete Kit

Back Clamp

- 3018 Black

Hardware

- 3017

Mounting Bracket

- 3016 Black

Hoop Frame

- 3015 Black

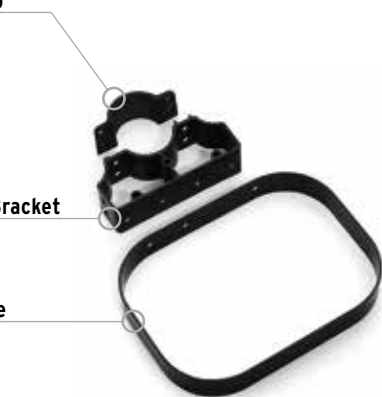

LOW STAND

Makes Trash Mate receptacles freestanding.

- 3030 Black



IN-GROUND TRASH MATE STAND

Make your Trash Mate freestanding to position it wherever it's needed. Steel bracket with double spikes keeps the Trash Mate in place and sturdy.

- 3031 Black



WALL MOUNT BRACKET

For any vertical surface. Includes all hardware.

- 475 Black



LIDS (Sold individually)

- 3010 "Cans Only" Lid



- 3011 Trash Lid



- 3012 Solid Lid



Keep par-3's up to par.

A low-profile Divot Mate® encourages golfers to fill divots on par-3's, leading to healthier turf and reducing maintenance time and effort required by your staff.

DIVOT MATE

- Poly construction prevents denting and rusting
- Maximum UV protection added to prevent brittleness and fading
- Large 4 gal. (15 liter) capacity
- Durable frame construction
- Handy 8 oz. (237 ml) plastic scoop included
- Usage decal sheet included



Key Feature
Self-closing lid.

DIVOT MATE (No stand)

Includes a small scoop and a 4 in. (10 cm) spike for additional stability on the ground.

- 425-00 Black
- 425-02 Hunter Green

CLEAR PLASTIC HAND SCOOP (Not shown)

400 8 oz. (237 ml)

456 16 oz. (473 ml)

GROUND MOUNTING SPIKE (Not shown)

457-4 Package of 4

PRACTICE RANGE ENSEMBLE

Towel not included. See page 12.

- 460-00 Black
- 460-02 Hunter Green

Replacement Parts
24 in. (61 cm) Mounting Pipe

- 212-00 Black
- 212-02 Hunter Green
- 212-99 Other color, please specify

Top Cap for Pipe

- 458 Black



WALL MOUNT BRACKET

Includes all hardware.

- 475 Black



DIVOT MATE WITH LOW STAND

- 435-00 Black
- 435-02 Hunter Green



DIVOT MATE WITH TALL STAND

- 430-00 Black
- 430-02 Hunter Green

LOW STAND ONLY

- 3030 Black

TALL STAND ONLY

- 470 Black

Put golfers on solid footing.

Even today's short plastic spikes collect debris and require cleaning. Our spike brushes ensure clean spikes and good footing at the tee, and less debris tracked in at the clubhouse. Attach them to every ball washer for player convenience and station a freestanding spike brush outside every clubhouse entrance.

SPIKE BRUSHES

- Crimped nylon bristles are dense to prevent matting, yet soft enough for both spikeless and plastic spiked shoes
- Base is made of black anodized cast aluminum, so there's no paint to chip



FLOOR MOUNT COMBINATION SPIKE AND SHOE CLEANER

549-11



SINGLE PIPE MOUNT SPIKE BRUSH

Mounts easily to ball washer pipe.

552-11



DOUBLE PIPE MOUNT SPIKE BRUSH

Mounts easily to ball washer pipe.

553-11



SPIKE BRUSH PARTS BASE BRUSH

554-11 Fits all models



SIDE BRUSH

548 Fits 549-11, 512-11 & 513-11 models



PIPE MOUNT BACK CLAMP

552-3 With hardware

PORTABLE SPIKE BRUSH

Offer the stability and cleaning effectiveness of a fixed-position brush stand that you can place wherever needed and on any surface.

- Patented design features base brushes and side brushes to thoroughly clean shoes
- Holds steady on hard surfaces with integral rubber pads; spikes available to secure to turf
- Includes one set of message decals

PORTABLE SPIKE BRUSH STAND

- 511-11 Black
- 512-11 Hunter Green

REPLACEMENT BRUSHES

- 554-11 Base Brush
- 548 Side Brush



CLUB WASHER

- Ultra-resilient, color-impregnated polypropylene cover and base provides years of service
- High-grade reversible bristles for extended life
- Twist-lock cover can be removed quickly, making cleaning easier
- Versatile design can be mounted to vertical or horizontal surfaces, or a ball washer pipe

CLUB WASHER*

- Capacity: 3.5 pt. (1.7 liter)
- 250-00 Black
- 250-02 Hunter Green

*Additional club washers (see pages 43 & 53)

REPLACEMENT BRUSHES

- 254 Set of two



OPTIONAL MOUNTING BRACKET

Mounts a Club Washer to any 2 in. (5 cm) pipe or any flat surface 6 in. (15 cm) or wider. Made of anodized cast aluminum. Nuts and bolts included.

- 275 Black



SINGLE SPIKE MOUNTING KIT

Bolts to bottom of Club Washer and moves as easily as a tee marker. Hardware included.

- 260 Black



Markers define your course's style.

With more styles and design flexibility, Par Aide tee markers let you make an impression at every tee. Enhance your brand and set your course apart with unique, customized FusionCast tee markers (see page 61). Or, select from several styles of traditional sphere or cube tee markers, the sophistication of low-profile domes or the natural allure of our branch style markers.

PAR AIDE TEE MARKERS

- Materials carefully chosen to include UV protection and incredible durability
- Designs are simple and classic; the style won't become outdated
- Markers will stand up to the elements and golfer abuse



Custom FusionCast tee markers available. See page 61.

PA Par Aide Exclusive
All tee markers feature rust-free stainless steel spikes.

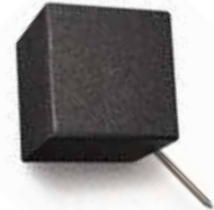

CAST ALUMINUM TEE MARKER

Durable cast aluminum with stainless steel placement spike. Can be repaired and repainted for a lifetime of use. A full 6 in. (15 cm) diameter. Contact Par Aide for custom color options.

- 655-1 Red
- 655-2 White
- 655-3 Blue
- 655-4 Yellow
- 655-5 Black
- 655-9 Custom

SATELLITE TEE MARKER

The Satellite tee marker is made of solid ABS plastic with a stainless steel spike. It won't split or crack, there's no paint to chip and UV protection makes it fade resistant. A full 4 1/2 in. (11 cm) diameter.

- 650-1 Red
- 650-2 White
- 650-3 Blue
- 650-4 Yellow
- 650-5 Black
- 650-6 Hunter Green

SPHERICAL PLASTIC TEE MARKER

Our most economical marker. Features welded, two-piece construction with molded-in stainless steel spike attached. A full 4 in. (10 cm) diameter.

- 640-1 Red
- 640-2 White
- 640-3 Blue
- 640-4 Yellow
- 640-5 Black

NEW CUBE TEE MARKER

Solid recycled plastic 4 in. x 4 in. (10 cm x 10 cm) tee markers feature stainless steel spikes and routed corners for cleaner edges.

- 633701 Red
- 633702 White
- 633703 Blue
- 633704 Yellow
- 633705 Green
- 633706 Black



NEW FORE-EVER MARKED™ TEE MARKERS

Known industrywide as the original, most durable, high-end resin tee markers.

Features

- Made from a special blend of resins
- UV stable and will never need painting
- Color pigments are added directly into the resin
- Incredibly durable with a high-gloss finish
- Stainless steel spike included but not attached
- Customizable with a one-color engraving

63530- __ 3 in. (8 cm) with Neck
63533- __ 3 in. (8 cm) with No Neck

63540- __ 4 in. (10 cm) with Neck
63543- __ 4 in. (10 cm) with No Neck

635411 4 in. (10 cm) Pink with Neck
635441 4 in. (10 cm) Pink with No Neck

635300 Custom Engraving



CUSTOM FORE-EVER MARKED TEE MARKERS

Color codes used as last digit when ordering*

1 - Red		6 - Green	
2 - White		7 - Orange	
3 - Blue		8 - Gold	
4 - Yellow		9 - Grey	
5 - Black			



No Neck

With Neck

***CUSTOM COLORS AVAILABLE | ADDITIONAL FEES APPLY**

RE-NEW-A-TEE

- Restore your Fore-Ever Marked Tee Markers to their original high-gloss finish
- Two-part clear coat epoxy kit
- Simply sand, clean and dip into epoxy and let dry overnight
- Restores approximately 175, 4 in. (10 cm) Tee Markers

635600 Re-New-A-Tee



CAST ALUMINUM LOW-PROFILE TEE MARKERS

Designed for a more subtle, lower-profile look, these tee markers are made of powder-coated cast aluminum with attached stainless steel spikes. Easy to repaint and refurbish. They'll add a classic look to your course. Contact Par Aide for custom color options.

1 3/8 in. (4 cm) high, 4 1/2 in. (11 cm) diameter

CAST ALUMINUM LOW-PROFILE TEE MARKERS

- 647-1 Red
- 647-2 White
- 647-3 Blue
- 647-4 Yellow
- 647-5 Black
- 647-6 Hunter Green
- 647-7 Gold
- 647-8 Silver
- 647-99 Custom



Key Feature

Customize tee colors to match your course tee locations.



BRANCH TEE MARKERS

Incredibly natural-looking Dogwood or Pine Tee Markers are made from a durable resin and are hand-painted. Ends are slanted for visibility and molded-in stainless steel spikes prevent rusting and bending.

- 9 1/2 in. x 2 in. (24 cm x 5 cm) – Dogwood
- 9 1/2 in. x 2 3/4 in. (24 cm x 7 cm) – Pine



PINE BRANCH TEE MARKER

- 630-1 Red
- 630-2 White
- 630-3 Blue
- 630-4 Yellow
- 630-5 Black
- 630-6 Hunter Green
- 630-7 Gold



DOGWOOD BRANCH TEE MARKER

- 632-1 Red
- 632-2 White
- 632-3 Blue
- 632-4 Yellow
- 632-5 Black
- 632-6 Hunter Green
- 632-7 Gold



CUSTOM DECALS

Minimum order of 36 decals, no art charge if vector art is supplied. Decals applied by customer.

520-2



BANDED TEE MARKERS

Designed to give your course an upscale look. These 5 in. (13 cm) diameter high-density plastic tee markers are virtually unbreakable and unsinkable. They identify tee locations with subtle color bands. Choose the natural color that best complements your course's scheme.

BANDED TEE MARKERS

Ordering is easy. Simply choose the color tee marker, then add the two-number code for the specific band color.

- 660-___ Charcoal Granite
- 661-___ Gray Granite
- 663-___ Sand Granite

INDIVIDUAL REPLACEMENT BANDS (Not shown)

660-1___ (Specify band, see options below)

- | | |
|-----------|-----------------|
| 01 Red | 05 Black |
| 02 White | 06 Hunter Green |
| 03 Blue | 07 Gold |
| 04 Yellow | 08 Silver |



Key Feature

Virtually indestructible and 5 in. (13 cm) diameter.



BAND COLOR OPTIONS

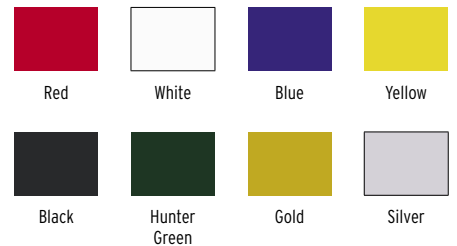

EVENT TEE MARKER

Make an event extra special for golfers by marking the tees with personalized messages. These cube-shaped markers allow you to display whatever you want – event graphics, the name of the hole sponsor or other information – on four surfaces. This popular option can be offered to outside event organizers or used for internal club events. The do-it-yourself decals can be easily printed at your facility using any color inkjet or laser printer. Designed with special adhesive, the decals hold securely, but can be removed leaving minimal residue after the event.

EVENT TEE MARKERS

Constructed of high-density plastic, each tee marker has four 4 in. x 4 in. (10 cm x 10 cm) "windows" to place decals. Decals sold separately. Overall size 5 in. x 5 in. x 5 in. (13 cm x 13 cm x 13 cm) Stainless steel spike.

- 670-1 Red
- 670-5 Black

DECALS

Do-it-yourself Easy-peel Decals 80/pack 4 in. x 4 in. (10 cm x 10 cm) compatible with inkjet or laser printers (enough for 20 tee markers).

670-10

Go to ParAide.com for tips and to print template.



Key Feature

Personalized tee markers for any kind of event.



GREENS PRODUCTS

ESTD



1955

The #1 flagstick in all of golf.

The difference is in the details. Our flagsticks offer unmatched durability, precision and fit, with a variety of styles, materials and colors, all with our legendary quality, features and value. From our proprietary grooved, gold-colored ferrule that removes out of the cup smoothly, to a range of flagstick styles for every requirement and budget, Par Aide products should be in your sights.

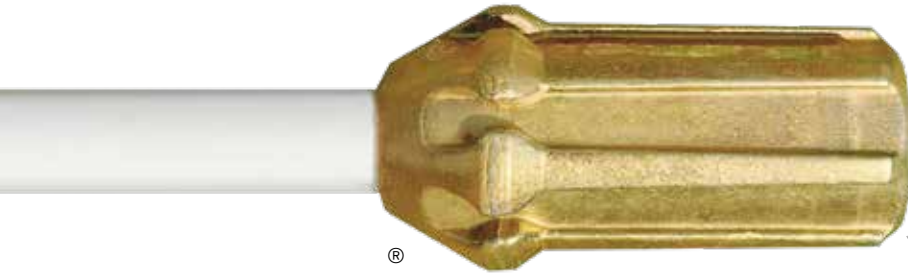

Par Aide's gold-colored ferrule is a registered trademark. The grooved ferrule is designed to nest firmly and glide out of the cup without resistance, reducing the chances of hole damage. This durable design also allows sand and other materials to completely pass through the cup.

SOLID REGULATION FIBERGLASS FLAGSTICKS – ½ IN. (1 CM)

Boxes of 9 – Best Value

5 ft. (1.5 m) Tall

730-059 Bright White

740-059 Bright Yellow

7 ft. 6 in. (2.3 m) Tall

730-0759 Bright White

740-0759 Bright Yellow



STRIPED REGULATION FIBERGLASS FLAGSTICKS – ½ IN. (1 CM)

Boxes of 9 – Best Value

5 ft. (1.5 m) Tall

720-059 3 Stripe Red & White

7 ft. 6 in. (2.3 m) Tall

725-0759 2 Stripe Red & White

727-0759 2 Stripe Blue & White - **NEW**

752-0759 2 Stripe Black & White

747-0759 2 Stripe Black & Yellow

720-0759 3 Stripe Red & White

750-0759 3 Stripe Black & White

755-0759 3 Stripe Green & White

7 ft. 6 in. (2.3 m) Tall

745-0759 Bright Yellow with 30 in. (76 cm) Black Bottom

754-0759 Bright White with 30 in. (76 cm) Black Bottom

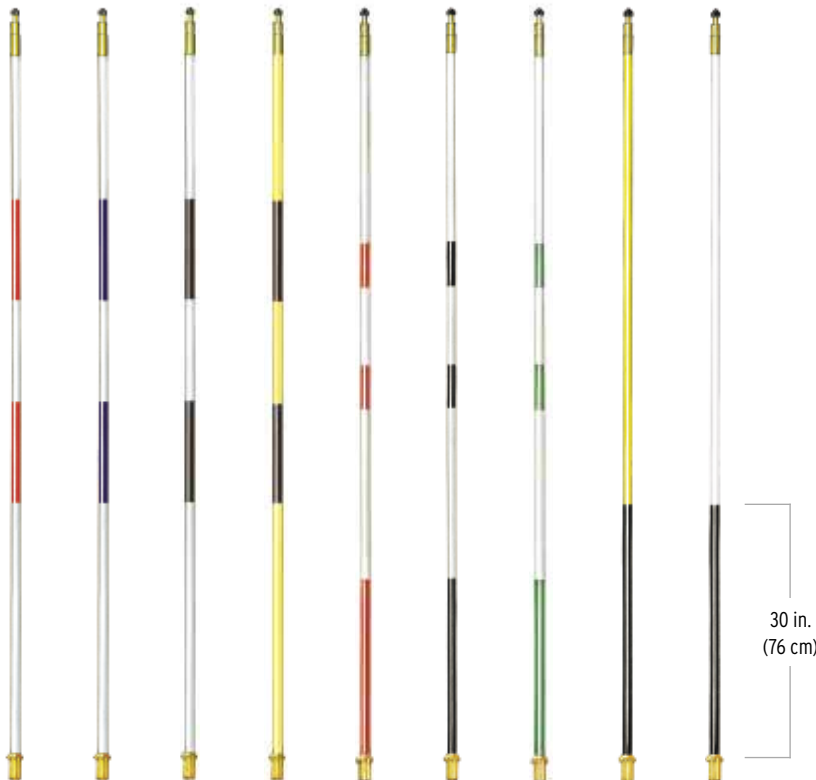

Flagsticks are available in 10 ft. (3.1 m) and 12 ft. (3.7 m) tall. Special shipping required. 7 ft. (2.1 m) and 8 ft. (2.4 m) tall sizes available but not stocked items. A custom order is required. Contact your Par Aide distributor for details.

Individual flagsticks are available for an additional cost.

TAPERED FIBERGLASS TOURNAMENT FLAGSTICKS

Tapered Tournament Flagsticks measure 7 ft. 6 in. (2.3 m) tall and taper from a ¾ in. (2 cm) diameter in the middle to ½ in. (1 cm) at the ends. They're more visible and offer a solid and sturdy look and feel.

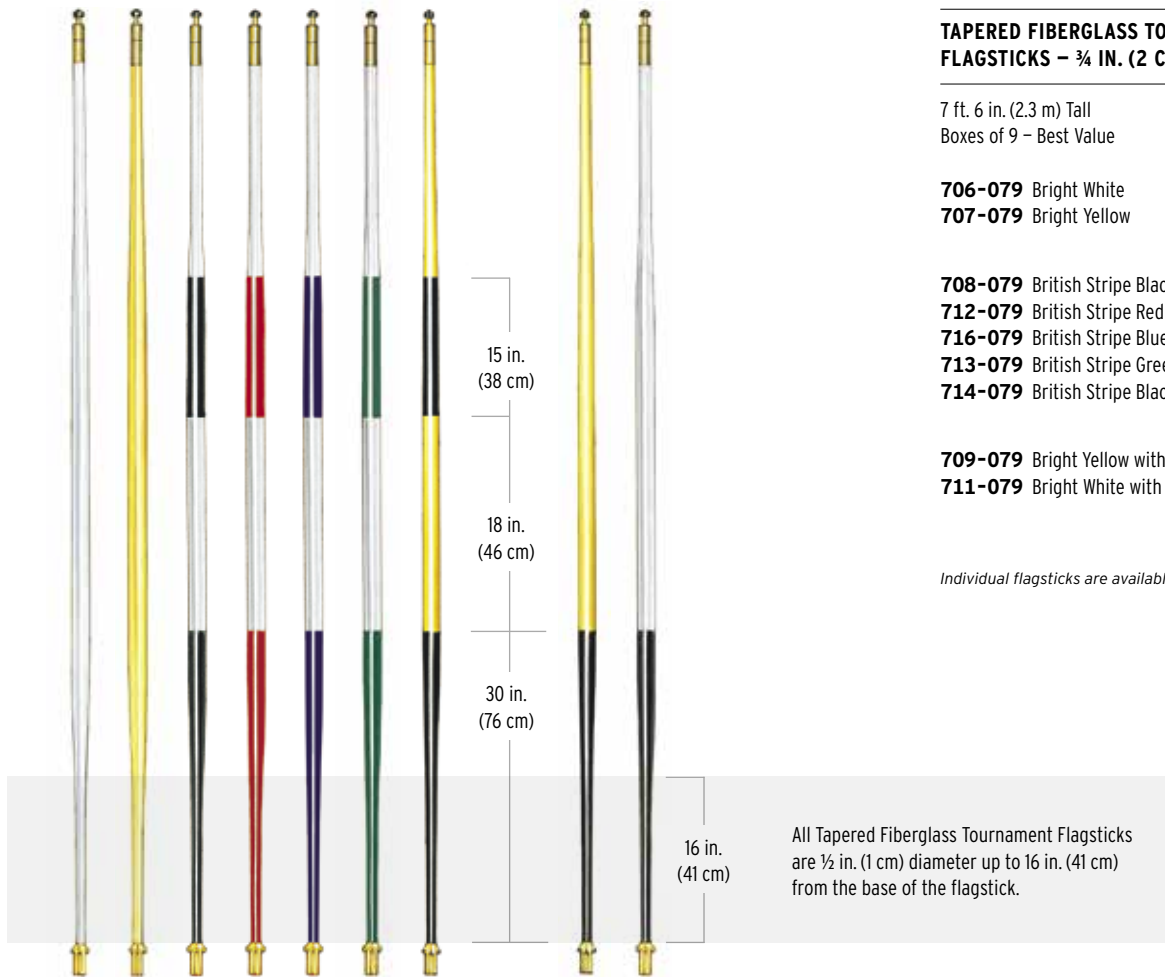

TAPERED FIBERGLASS TOURNAMENT FLAGSTICKS – ¾ IN. (2 CM)

7 ft. 6 in. (2.3 m) Tall
Boxes of 9 – Best Value

706-079 Bright White
707-079 Bright Yellow

708-079 British Stripe Black & White
712-079 British Stripe Red & White
716-079 British Stripe Blue & White - **NEW**
713-079 British Stripe Green & White
714-079 British Stripe Black & Yellow

709-079 Bright Yellow with 30 in. (76 cm) Black Bottom
711-079 Bright White with 30 in. (76 cm) Black Bottom

Individual flagsticks are available for an additional cost.

FLAGSTICK PARTS

Package of 6
1729-6 Ferrule



Package of 6
1733-6 Acorn Nut



Package of 6
1732-6 Top Stud

Key Feature

Extend flagstick life easily with a replacement ferrule.

ALUMINUM/FIBERGLASS TOURNAMENT FLAGSTICKS

A full 8 ft. (2.4 m) tall, this lightweight, exclusive Par Aide design meets USGA regulations.

- Ultimate visibility
- Top and bottom shanks are ½ in. (1 cm) diameter, color-impregnated fiberglass in Bright Yellow, Bright White or Black
- Flagstick body is 1 in. (3 cm) diameter aluminum
- Powder-coated body allows for a completely custom look. Colors and patterns can be changed to accommodate your course needs

ALUMINUM/FIBERGLASS TOURNAMENT FLAGSTICKS – 1 IN. (3 CM)

8 ft. (2.4 m) Tall Boxes of 9 – Best Value	705-089 Three Black Stripes (As shown)
701-089 Bright Yellow 702-089 Bright White	703-99 One Custom Stripe
703-089 One Black Stripe (As shown)	704-99 Two Custom Stripes
704-089 Two Black Stripes (As shown)	705-99 Three Custom Stripes

Individual flagsticks are available for an additional cost.

Key Feature

Highly visible. Easy to customize.

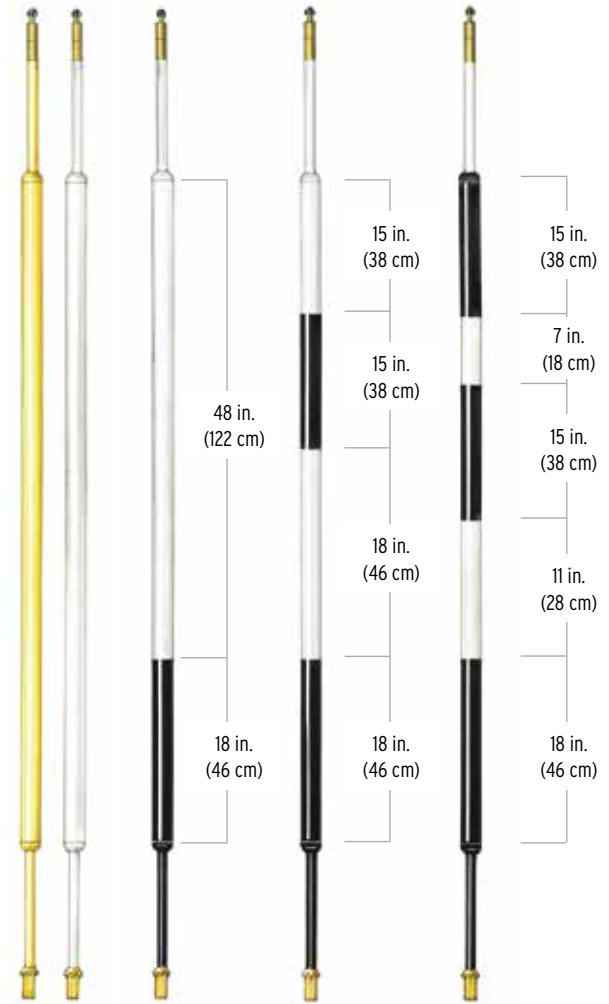

QUICK RELEASE TOP STUD

Saves time by allowing the flag to be removed or replaced by simply pulling the flag tube on or off. Screws onto top stud and holds flag firmly.

- Eliminates acorn nuts while securing flag to flagstick
- Package of 10

Email us at info@ParAide.com for a free sample.

QUICK RELEASE TOP STUD

1740-10



Key Feature

Eliminates acorn nut, making flag removal quick and easy.

[View product demo at ParAide.com](#)



VINYL-COVERED FLAGSTICKS

Our vinyl-covered flagsticks are available in popular colors and striping patterns in both ½ in. and ¾ in. (1 cm and 2 cm) models. All flagsticks come pre-applied with vinyl shrink-wrap coverings to save you time and money when considering a long-lasting vinyl-covered flagstick option.

- Prevents fiberglass from fading, nicking or scratching
- Pre-assembled for convenience, no heat gun use required
- Protection against damage from abrasion, UV rays, chemicals and the elements

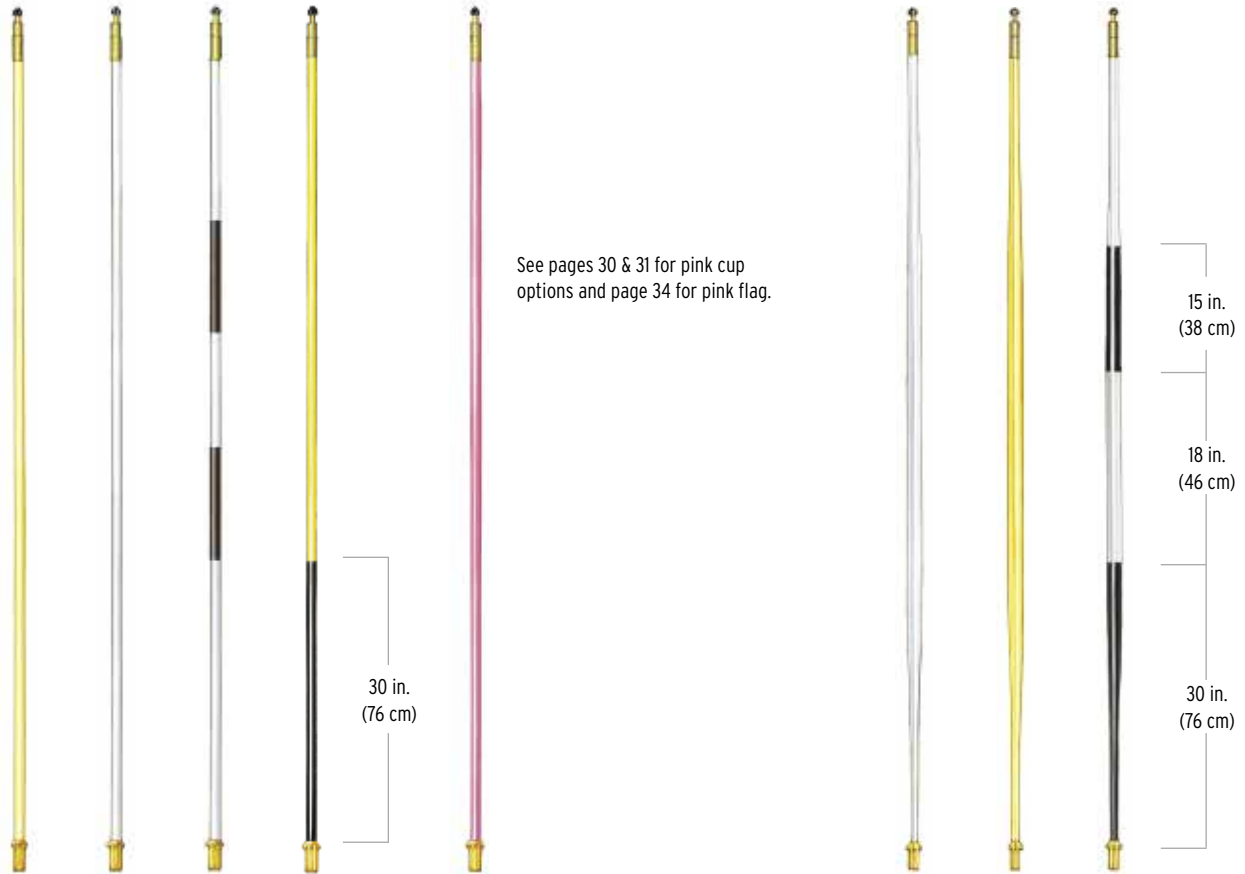

VINYL-COVERED FIBERGLASS FLAGSTICKS – ½ IN. (1 CM)

7 ft. 6 in. (2.3 m) Tall
Boxes of 9 – Best Value

740-0759-2 Bright Yellow
730-0759-2 Bright White

745-0759-2 Bright Yellow with 30 in. (76 cm) Black Bottom

710-99-2 Pink

752-0759-2 Two Stripe Black & White

VINYL-COVERED TAPERED FIBERGLASS TOURNAMENT FLAGSTICKS – ¾ IN. (2 CM)

7 ft. 6 in. (2.3 m) Tall
Boxes of 9 – Best Value

706-079-2 Bright White
707-079-2 Bright Yellow

708-079-2 British Stripe Black & White

Individual flagsticks are available for an additional cost.

PRISM FLAGSTICKS

Presenting two ways to make laser distance measuring devices easier to use and more accurate on your golf course. Our Prism Flagsticks integrate the reflecting prisms into the body of the flagstick while our PinSite® Reflector screws onto the flagstick in place of the acorn nut.

- For use with all laser golf distance measuring devices including Bushnell®, Laser Link®, Leupold®, Nikon®, Callaway® and others
- Premium glass prisms for maximum accuracy
- Prism Flagsticks are machine drilled, allowing precise insertion of prisms
- Available in ½ in. (1 cm) and ¾ in. (2 cm) tapered models

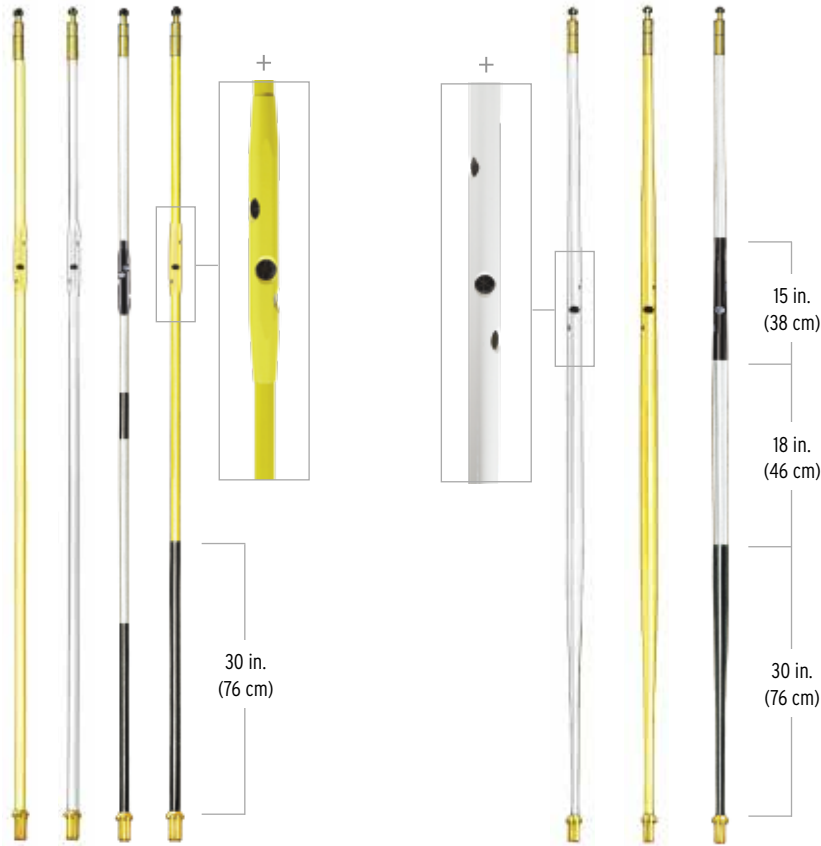

PINSITE REFLECTOR

With our patented PinSite Reflector, convert any existing flagstick to give precise readings to laser distance measuring devices. Screws in place of acorn nut. Nylon thread prevents seizing to the top of the flagstick.



PRISM FIBERGLASS FLAGSTICKS – ½ IN. (1 CM)

7 ft. 6 in. (2.3 m) Tall
Boxes of 9 – Best Value

- 740-0759-1** Bright Yellow
- 730-0759-1** Bright White

750-0759-1 Three Stripe Black & White

745-0759-1 Bright Yellow with 30 in. (76 cm) Black Bottom

PRISM TAPERED FIBERGLASS TOURNAMENT FLAGSTICKS – ¾ IN. (2 CM)

7 ft. 6 in. (2.3 m) Tall
Boxes of 9 – Best Value

- 706-079-1** Bright White
- 707-079-1** Bright Yellow

708-079-1 British Stripe Black & White Pin

PINSITE REFLECTOR



1736

Individual flagsticks are available for an additional cost.

Perfect every putt.

Eliminate tedious cup restoration and present a perfect cup every time. The patented Ever-White® Cup combines a worry-free aluminum cup with replaceable bright white cup liners, offering premium perfection in appearance, performance and, yes, the classic sound of a dropped putt.



EVER-WHITE CUP

- The patented Ever-White Cup has revolutionized the putting cup by teaming an aluminum outside with a bright white plastic sleeve
- No paint to chip, eliminating the need for stripping, sanding and painting
- Easily replaceable sleeve stays tight in the cup during play
- Resonates with the classic aluminum sound when the ball drops in

PA Par Aide Exclusive

The Ever-White Cup with replaceable white liner. Patented, seamless and original.

[View product demo at ParAide.com](#)

EVER-WHITE CUP



Patented aluminum cup complete with plastic sleeve. Meets all USGA regulations.

935



EVER-WHITE CUP REPLACEMENT SLEEVES

Case of 18 (Sleeves not sold individually).

935-1

CUSTOM DECAL FOR EVER-WHITE SLEEVE

Celebrate special events with this surprising extra touch. Minimum order 36 decals – only one logo is included in the minimum order. No art charge when vector art is supplied. Sleeves and decals sold separately. Customer applies decal.

520-1



PINK REPLACEMENT SLEEVES

Case of 18 (Sleeves not sold individually).

935-4





REGULATION PLASTIC CUP

Durable bright white plastic cup featuring minimum taper for a snug fit, both on the course and on the practice green. Meets all USGA regulations.

920 6 in. (15 cm) Regulation Cup



PRACTICE GREEN PLASTIC CUP

Durable bright white plastic cup featuring minimum taper for a snug fit. Meets all USGA regulations.

940 4 in. (10 cm) Practice Cup



ALUMINUM CUP

Our classic – it's die-cast oversize, then machined to dimensions that minimize "wobble" in the hole. Surfaces anodized and dichromated for ultimate corrosion protection. The cup's vertical surfaces are powder-coated bright white and the bottom is unpainted so there's no paint to chip. Meets all USGA regulations.

930 6 in. (15 cm) Regulation Cup

See page 28 for pink flagstick and page 34 for pink flag.



PINK CUP

Designed to coordinate with pink flagsticks and flags for breast cancer awareness or other pink-themed events.

930-99 6 in. (15 cm) Regulation Cup

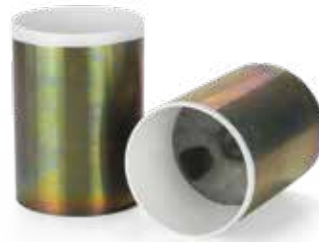

ZINC CUP

Same characteristics as the aluminum model but molded in zinc for improved overall strength. Zinc also increases weight of cup for more stability. Inside of cup powder-coated white. Meets all USGA regulations.

937 6 in. (15 cm) Regulation Cup



CUP STOP

By inserting this rigid plastic disk into the bottom of the cup, the cup will not "sink" into the green once it is set. Also prevents flagsticks from "bottoming out." Sold in sets of 18.

932 Use with Par Aide cup model numbers 920, 930 and 935 only



FOAM CUP RISER

Par Aide's Foam Cup Riser is the cleanest, most attractive way to adjust cup hole height and reduce touchpoints. The Foam Cup Riser is manufactured specifically to fit in a regulation size putting cup and the height is set precisely to be able to remove the golf ball without touching the flagstick or cup. Case of 9 (risers not sold individually).

- Bright white – clean look that matches the color of the cup
- Universal fit – fits all putting cups and flagsticks on the market
- 3 ¾ in. (10 cm) wide – fills the entire inside of the cup vs. a 2 in. (5 cm) pool noodle
- 2 ½ in. (6 cm) high – appropriate height to retrieve ball
- Sold in sets of 9 plugs

912 Set of 9



NEW GOLF HOLE RING

Using a Golf Hole Ring helps maintain the integrity of the cup hole edges, which are being damaged at a higher rate because of the new USGA rule allowing the flagstick to be left in while putting. The bright white ring makes the hole more visible and creates the same visual effect as hole paint, without labor and clean-up. Use with the Golf Hole Ring Cup Setter to easily install the ring when setting the cup.

651620 White (Set of 18)



NEW GOLF HOLE RING CUP SETTER

Our new powder-coated aluminum cup setter is specifically designed to install our Golf Hole Ring when setting cups. Slip a ring onto the cup setter, install the cup, give the cup setter a ¼-turn and both the cup and ring are properly installed.

655626



EDGE-SAVER™

The Edge-Saver is an easy to use device that removes golf balls from the cup without damaging the hole. It attaches to any Par Aide flagstick and nests perfectly into the grooves of our ferrule. The Edge-Saver is designed to freely move up and down the flagstick, further minimizing any damage when removing or replacing in the cup.

1725



BIG CUPS

Made of durable white plastic to stand up to the elements, they provide an incredibly inviting target for youth and beginning golfers.

- Durable bright white plastic
- 3 in. (8 cm) tall
- Available in two sizes



925 8 in. (20 cm) Big Cup



927 15 in. (38 cm) Big Cup

BIG CUP HOLE CUTTERS

We fitted a proven Par Aide Hole Cutter with an 8 in. and 15 in. (20 cm and 38 cm) blade. The cutters have pistons for removing very large plugs. The blades are heat-treated steel to produce clean cuts every time.

- Heat-treated blades
- Cuts 3 ¼ in. (8 cm) deep
- Available in two sizes



1004 15 in. (38 cm) Hole Cutter



1005 8 in. (20 cm) Hole Cutter (Complete)

1012 8 in. (20 cm) Adapter Only (Blade, Piston and Hardware)

CUSTOM LOGO FLAGS

Better materials, superior workmanship and faster delivery makes our custom logo flags the best choice for your course. Par Aide custom embroidered and screen-printed flags offer:

- Color-protected fabric for maximum resistance to fading
- Colorfast thread, specifically designed for outdoor use
- Reinforced stitching
- Visit ParAide.com for flag colors



Key Feature

Embroidered or screen-printed Jr. Flags are a great addition to any practice green.



EMBROIDERED FLAGS

- Made of 400 denier nylon – a durable, heavyweight fabric that resists puckering to give your flag a better appearance
- Exclusive “reverse-bobbed” stitching provides extraordinary detail on both sides of the flag and eliminates unsightly white threads
- Twelve flag minimum order quantity
- The quickest turnaround times in the industry
- Contact your Par Aide distributor with high-resolution, vector-based artwork of your logo to get a price quote*

*Low-resolution artwork may be used but will require an additional art charge.

SCREEN PRINTED FLAGS

- Made of durable 200 denier nylon – the most popular fabric for screen printed flags
- Also available in 400 denier flags
- Nine flag minimum order quantity
- The quickest turnaround time in the industry
- Contact your Par Aide distributor with high-resolution, vector-based artwork of your logo to get a price quote*



Flags that signal course quality.









The bold, true colors of Par Aide’s premium flags are built to withstand the demands of sun, wind and rain. Designed with ultra-durable, fade-resistant nylon fabrics in a choice of weights, the strongest stitching and highest quality construction, our flags stand tall, season after season.

Key Feature

Four full rows of fly hem stitching.



SOLID-COLOR FLAGS – 200 DENIER





-  Red
8102 Tube-Style
-  White
8112 Tube-Style
-  Blue
8122 Tube-Style
-  Yellow
8132 Tube-Style
-  Orange
8142 Tube-Style
-  Green
8162 Tube-Style
-  Pink
8164 Tube-Style
-  Color Flag Set
Package of 3 Red, 3 White, 3 Blue
8126 Tube-Style

SOLID-COLOR FLAGS – 400 DENIER



-  Red
8200 Tube-Style
-  White
8201 Tube-Style
-  Blue
8202 Tube-Style
-  Yellow
8203 Tube-Style
-  Green
8204 Tube-Style
-  Color Flag Set
Package of 3 Red, 3 White, 3 Blue
8210 Tube-Style

Black, Navy Blue, Burgundy and Gold also available in 400 denier.

NUMBERED FLAGS – 200 DENIER

-  **8** White on Red
8302 Tube-Style 1-9
8304 Tube-Style 10-18
-  **8** Red on White
8312 Tube-Style 1-9
8314 Tube-Style 10-18
-  **8** Black on Yellow
8332 Tube-Style 1-9
8334 Tube-Style 10-18
-  **8** White on Blue
8322 Tube-Style 1-9
8324 Tube-Style 10-18

CHECKERED FLAGS

-  Red & White
8502 Tube-Style
-  Blue & White
8512 Tube-Style
-  Black & White
8522 Tube-Style
-  Black & Yellow
8532 Tube-Style
-  Green & White
8562 Tube-Style

REGULATION U.S. GOLF FLAG

Patented digital process and unique material creates an unmatched single layer, double-sided replica U.S. flag.

8684 Regulation U.S. Golf Flag





PRACTICE GREEN FLAGS

Match the practice green flags with the regulation flags on your course.

Jr. Flags Solid

- 9200 Red
- 9202 White
- 9204 Blue
- 9206 Yellow

Numbered

- 9251 White on Red 1-9
- 9252 White on Red 10-18
- 9261 Red on White 1-9
- 9262 Red on White 10-18
- 9281 Black on Yellow 1-9
- 9282 Black on Yellow 10-18

Checked

- 9300 Red & White
- 9320 Black & White
- 9330 Black & Yellow
- 9360 Green & White

JR. U.S. GOLF FLAG

Patented digital process and unique material creates an unmatched single layer, double-sided replica U.S. flag.

- 8685 Jr. U.S. Golf Flag

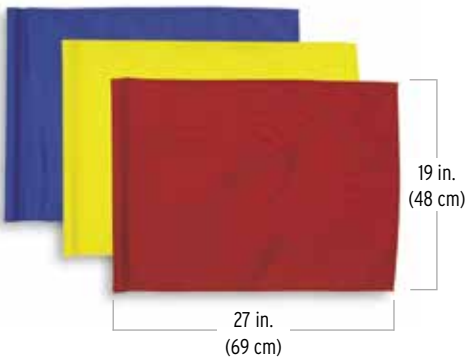

PIN PLACEMENT INDICATORS

For 1/2 in. (1 cm) Fiberglass Flagsticks

- 770-01 Red
- 770-02 White
- 770-03 Yellow
- 770-04 Blue
- 775-01 Red Flag with White Printing
- 775-02 White Flag with Red Printing
- 775-03 Yellow Flag with Black Printing
- 775-04 Blue Flag with White Printing

For Tapered 3/4 in. (2 cm) Tournament Flagsticks

- 790-01 Red
- 790-02 White
- 790-03 Yellow
- 790-04 Blue
- 795-01 Red Flag with White Printing
- 795-02 White Flag with Red Printing
- 795-03 Yellow Flag with Black Printing
- 795-04 Blue Flag with White Printing

OVERSIZED RANGE FLAGS

Highly visible flags designed especially for the range. 27 in. x 19 in. (69 cm x 48 cm). Sold individually.

Solid

- 8610 Red
- 8611 White
- 8612 Royal Blue
- 8613 Yellow
- 8614 Green
- 8615 Orange
- 8616 Gold
- 8617 Black

Checked

- 8620 Red & White
- 8621 Black & White
- 8622 Blue & White
- 8623 Yellow & White
- 8624 Green & White
- 8625 Black & Yellow





PRACTICE AREA



WOOD PRACTICE GREEN MARKERS

Attract more golfers to the practice green with our handsome Wood Practice Green Markers. Not only do they improve the look of the practice green, these markers complement the classic look of golf.

- Solid metal base for added strength and durability
- Made of dense hardwood
- Flagstick is 34 in. (86 cm) tall for the golfer's convenience
- Tapered at both ends and provides a classic look
- Finished with natural teak oil. To restore luster, re-apply teak oil periodically



 [View product demo at ParAide.com](https://www.ParAide.com)

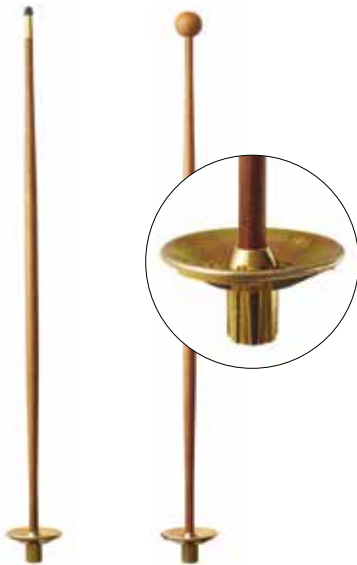

INDIVIDUAL WOODEN PRACTICE GREEN MARKER WITH METAL BASE

9120 Wood Practice Green Marker
(Combine with any Jr. Flag from page 35)

9121 Wooden Knob Practice Green Marker
(Permanently fixed knob makes a flag unnecessary)



INDIVIDUAL CUPLESS PRACTICE GREEN MARKER

9120-2 Cupless Wood Practice Green Marker
(Combine with any Jr. Flag from page 35)

9121-2 Cupless Wooden Knob Practice Green Marker
(Permanently fixed knob makes a flag unnecessary)



OPTIONAL WOODEN KNOB FOR WOOD PRACTICE GREEN MARKERS

- Easier to grasp, keeps flags cleaner
- Must order as optional item
- Works only on model numbers 9120 and 9120-2

Package of 9
9098-9

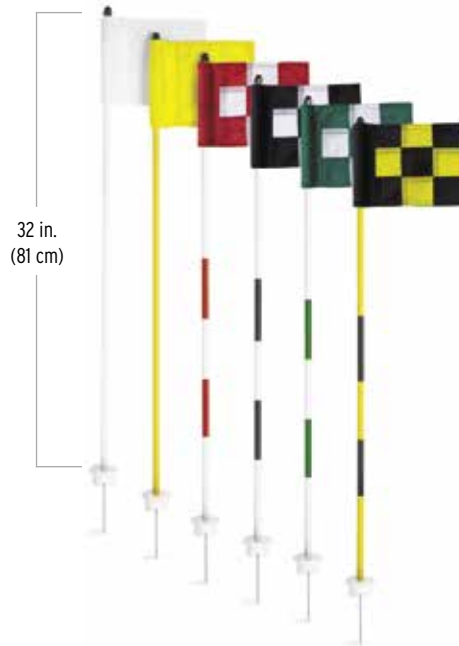
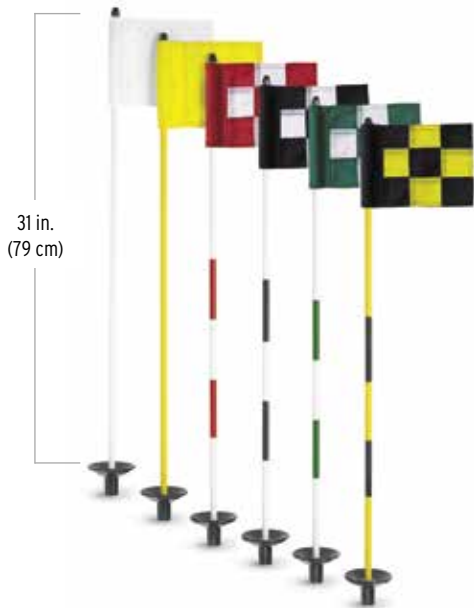

JR. FLAGSTICK MARKER/FLAG SETS

- Same ½ in. (1 cm) fiberglass as regulation flagsticks, only shorter – 31 in. (79 cm)
- Set includes nine markers with nine flags. Below are our most popular combinations

9190-9 Bright White Flagstick with White Flag
9191-9 Bright Yellow Flagstick with Yellow Flag

9192-9 Red & White Flagstick with Red & White Flag
9193-9 Black & White Flagstick with Black & White Flag
9194-9 Green & White Flagstick with Green & White Flag
9195-9 Black & Yellow Flagstick with Black & Yellow Flag

CUPLESS JR. FLAGSTICK MARKER/FLAG SETS

- Same ½ in. (1 cm) fiberglass as regulation flagsticks, only shorter and with a spike to eliminate cutting cups – 32 in. (81 cm)
- Set includes nine markers with nine flags. Below are our most popular combinations

9190-29 Bright White Flagstick with White Flag
9191-29 Bright Yellow Flagstick with Yellow Flag

9192-29 Red & White Flagstick with Red & White Flag
9193-29 Black & White Flagstick with Black & White Flag
9194-29 Green & White Flagstick with Green & White Flag
9195-29 Black & Yellow Flagstick with Black & Yellow Flag

TOURNAMENT JR. MARKER/FLAG SETS

- 35 in. (89 cm) tall
- Same design as the popular 8 ft. (2.4 m) Aluminum Tournament Flagsticks
- Top and bottom shanks are solid ½ in. (1 cm) diameter fiberglass, body is 1 in. (3 cm) diameter aluminum
- Set includes nine markers with nine flags. Below are our most popular combinations

9110-9 Bright White Flagstick with White Flag
9111-9 Bright Yellow Flagstick with Yellow Flag

9112-9 Red & White Flagstick with Red & White Flag
9113-9 Black & White Flagstick with Black & White Flag
9114-9 Green & White Flagstick with Green & White Flag
9115-9 Black & Yellow Flagstick with Black & Yellow Flag

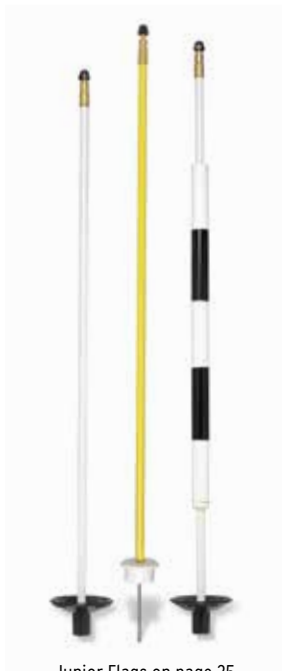

Junior Flags on page 35



33 in.
(84 cm)

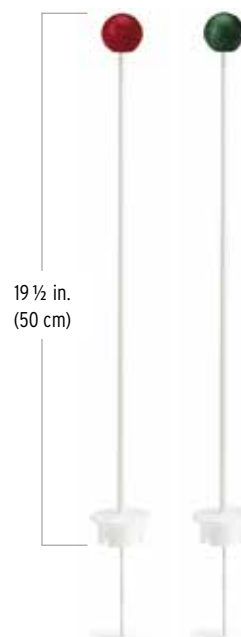

19 1/2 in.
(50 cm)

INDIVIDUAL PRACTICE GREEN MARKER JR. FLAGSTICKS

- 9190 Bright White
- 9191 Bright Yellow

- 9192 Red & White
- 9193 Black & White
- 9194 Green & White
- 9195 Black & Yellow

Cupless Jr. Flagsticks

- 9190-2 Bright White
- 9191-2 Bright Yellow

- 9192-2 Red & White
- 9193-2 Black & White
- 9194-2 Green & White
- 9195-2 Black & Yellow

Tournament Jr. Flagsticks

- 9110 Bright White
- 9111 Bright Yellow

- 9112 Red & White
- 9113 Black & White
- 9114 Green & White
- 9115 Black & Yellow

EXECUTIVE PGMs

33 in. (84 cm) tall for the golfer's convenience. Available in Red and Hunter Green, with or without numbers. Non-tip designed base. Shipped fully assembled. Sold in sets of nine or individually.

Executive PGM Sets

- 9171-01 Red (Numbers 1-9)
- 9171-02 Hunter Green (Numbers 1-9)
- 9172-01 Red (Numbers 10-18)
- 9172-02 Hunter Green (Numbers 10-18)
- 9170-01 Red (Without Numbers)
- 9170-02 Hunter Green (Without Numbers)

Single Executive PGM

- 9181-___ Red (Specify Number 1-18)
- 9182-___ Hunter Green (Specify Number 1-18)
- 9181-0 Red (Without Number)
- 9182-0 Hunter Green (Without Number)

CUPLESS PRACTICE TARGETS

19 1/2 in. (50 cm) tall. Meant to serve as a supplement to regular practice green markers during high-traffic times and special events. Ideal for courses where time and/or budget don't allow for regular changing of practice green cups. Also great for placing on or off the green for chip shot practice.

- 9090-00 Black
- 9090-01 Red
- 9090-02 Hunter Green
- 9090-03 Yellow
- 9090-04 Blue
- 9090-06 White

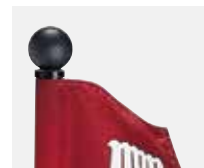

OPTIONAL KNOB FOR JR. FLAGSTICKS

Easier to grasp, keeps flags cleaner. Must order as optional item.

- Package of 9
- 9099-9 Black

SURE PUTT™

Putting to the smaller cup – 3 in. (8 cm) diameter compared to a regulation cup of 4 ¼ in. (11 cm) diameter – dramatically helps focus the golfer's aim and trains them to make a more accurate putting stroke. The Sure Putt Practice Green System is a complete system that is widely regarded as the finest putting aid for any level of golfer. Offered at a tremendous value, it includes:

- A Hole Cutter designed to cut a 3 in. (8 cm) wide by 3 ½ in. (9 cm) deep hole
- 3 metal putting cups, 3 in. x 3 ½ in. (8 cm x 9 cm)
- Cup Puller (not shown)



 [View product demo at ParAide.com](#)

SURE PUTT PRACTICE GREEN SYSTEM

10710 Sure Putt System (includes Hole Cutter, 3 Cups and Cup Puller)

10702 Putting Cup only

10703 "Do The Drill" Sign



 **Par Aide Exclusive**
Great teaching aid at a great value.

Best practices for top practice areas.

The top courses know that a well-equipped practice area signals the quality of your entire facility. Make your guests feel like professionals with the accessories and conveniences they need to improve their game and prepare for their rounds.

ROLLING BALL PICKER

Make collecting balls and cleaning up practice areas quick and easy with the Rolling Ball Picker. Lightweight, compact and easy to use, it replaces heavy, bulky PVC collectors and shag bags that hold fewer golf balls and can easily damage greens.

- Holds up to 80 golf balls
- 50 in. (1.3 m) wooden handle
- Head features 60 metal spokes that separate with little effort when collecting balls
- Balls are easily removed by separating the spokes



ROLLING BALL PICKER

10755



 [View product demo at ParAide.com](#)

PROXIMITY MARKERS & CONTEST INDICATORS

Have these accessories on hand for special events. Announce the contest on a hole with a contest indicator on the tee. Place proximity markers in the fairway or green to mark longest drive, closest to the pin or other contests.

- Paper-free Proximity Marker includes an attached grease pen, Contest Indicator, unattached grease pen
- Choose stock design or customize with course or event logo
- Cleanup: Wipe with a clean towel using any household cleaner or WD-40®
- Reusable, rainproof Polycarbonate surface eliminates messy paper sheets
- Stake: 24 in. (61 cm) tall
- Sign face: 6 in. x 8 in. (15 cm x 20 cm)



REPLACEMENT PARTS

10690 Replacement Pen with Velcro (Chain not included) **10691** Tube of 6 Replacement Leads

PROXIMITY MARKER

10600 Generic
10620 Custom

CONTEST INDICATOR

10602 Generic
10622 Custom

[View product demo at ParAide.com](http://ParAide.com)

PRACTICE RANGE SIGNS

- These signs will last 10 times longer than their PVC counterparts
- Highly visible, easy to move for ball collection and mowing
- Frames are made of durable steel, powder-coated black for protection
- One-piece construction prevents the numbers from separating from sign
- Signs are 3/8 in. (1 cm) thick molded rubber

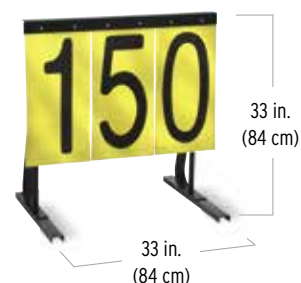

PRACTICE RANGE SIGNS

For any distance from 100 yd. (91 m) to 275 yd. (251 m) in increments of 25 yd. (22 m). Comes complete with frame.

Black & White Numbers	Yellow & Black Numbers
10200-01 100	10300-01 100
10200-02 125	10300-02 125
10200-03 150	10300-03 150
10200-04 175	10300-04 175
10200-05 200	10300-05 200
10200-06 225	10300-06 225
10200-07 250	10300-07 250
10200-08 275	10300-08 275

PRACTICE RANGE SIGN REPLACEMENT PARTS

- Individual Numbers
10210-00 0 Black
10310-00 0 Yellow
10210-01 1 Black
10310-01 1 Yellow
10210-02 2 Black
10310-02 2 Yellow
10210-05 5 Black
10310-05 5 Yellow
10210-07 7 Black
10310-07 7 Yellow



Frame only (with all hardware)
10200



RECYCLED PLASTIC

ESTD



1955

The Woods Collection.

Named after the stunning Minnesota “Lake of the Woods” and the “wood” grain that distinguishes these products, this original, classic collection of recycled plastic products are designed to differentiate and set your course apart. The difference in these traditional golf course furnishings is in the details. Each product is handcrafted in our Minnesota workshop using recycled lumber boards with textured wood grain throughout, resulting in beautiful, classic designs that will enhance the image of any golf course.

From the practice tee and all around your facility, The Woods Collection of recycled plastic products deliver an exceptional look and feel and are virtually indestructible. Each product is available in four popular timeless colors that never require painting or staining.



Hunter Green



Black



Redwood

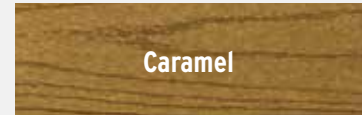

Caramel

Color options available for Eco-Enclosures



RANGE CRATE

Give your driving range a sophisticated look with little to no maintenance compared to pyramids, baskets or bags.

- Holds up to 300 balls
- Angled interior distributes balls out the front
- Transport easily with steel trap door
- Stack multiple units together

- 3440** Hunter Green
- 3441** Black
- 3442** Redwood
- 3443** Caramel

Key Feature

Angled interior allows for balls to be easily distributed.



RANGE PRO

- Convenient 25 in. (64 cm) height
- Eliminate unsightly water buckets
- Stainless steel hinged lid
- Brush secured to unit
- Includes: Pre-assembled housing, towel bar and hooks, hand brush, square 4 gal. (11.3 liter) plastic container

- 3310** Hunter Green
- 3315** Black
- 3316** Redwood
- 3317** Caramel

Key Feature

Stainless steel hinges add durability and black bucket makes dirty water less noticeable.



TRASH PRO 30

- Recycled plastic-wood slats over a sturdy frame for durability and stability
- Front access permits easy removal and replacement of trash bag and allows either side, or the back of the container, to be placed against a wall
- Custom-molded plastic roof adds aesthetic value
- Integral trash bag frame accepts 40 gal. (151.4 liter) trash bags
- 28 in. L x 22 in. W x 43 in. H (71 cm L x 56 cm W x 109 cm H)

- 3810** Hunter Green
- 3811** Black
- 3812** Redwood
- 3813** Caramel

CUSTOM LOGO PLACARD

Customize Par Aide Eco-Enclosures with your course's logo. Minimum order of four placards, no art charge if vector art supplied. Receive free Custom Logo Placards when ordering at least four Eco-Enclosures. Excludes Broken Tee Boxes. Customer applies logo placards.

520-3



TRASH PRO 20

- Large capacity is ideal near the clubhouse, halfway house or the first and tenth tees
- Hinged lid allows easy removal of 20 gal. (75.7 liter) plastic can (included)
- Accepts 20 gal. (75.7 liter) plastic trash can liners
- 20 in. L x 20 in. W x 32 in. H (51 cm L x 51 cm W x 81 cm H)

- 3830** Hunter Green
- 3831** Black
- 3832** Redwood
- 3833** Caramel

TRASH PRO 10

- Hinged lid permits easy removal of 10 gal. (37.8 liter) plastic can (included)
- Accepts 10 gal. (37.8 liter) plastic trash can liners
- 18 in. L x 14 in. W x 33 in. H (46 cm L x 36 cm W x 84 cm H)

- 3820** Hunter Green
- 3821** Black
- 3822** Redwood
- 3823** Caramel





DIVOT PRO JR.

- Low profile contributes to uncluttered look on tee box
- Hinged lid keeps mix dry and accessible
- 5 gal. (18.9 liter) plastic inner liner is easily removed for cleaning, filling or changing. Includes 8 oz. (237 ml) scoop
- 19 in. L x 15 in. W x 13 in. H (48 cm L x 38 cm W x 33 cm H)

- 3420** Hunter Green
- 3421** Black
- 3422** Redwood
- 3423** Caramel



DIVOT PRO ACCESSORIES

Clear Plastic Hand Scoop

400 8 oz. (237 ml)

456 16 oz. (473 ml) (Not shown)

ROLLER KIT (Not shown)

Roller Kit can be easily mounted to many of the Par Aide recycled plastic units, enabling them to be rolled rather than lifted for moving (can mount to Trash Pro 10, Range Pro and Divot Pro).

- Two wide rollers distribute weight evenly for easy movement
- Reduces back strain

3425

CLOCK PRO

- Perfect for first and tenth tees and driving range
- Includes temperature and humidity meter
- Available with one or two clocks

Single-Sided (One clock)

- 3320** Hunter Green
- 3321** Black
- 3324** Redwood
- 3325** Caramel



Double-Sided (Two clocks)

- 3322** Hunter Green
- 3323** Black
- 3326** Redwood
- 3327** Caramel

CLOCK

- Comes complete with outdoor clock and mounting hardware that allows it to be mounted to any Par Aide recycled plastic unit
- Includes temperature and humidity meter

3690



46 RECYCLED PLASTIC | The Woods Collection Water Pro™ & Water Pro™ Jr.

WATER PRO™

- Double door and a built-in locking system make the cooler easily accessible
- Front access to cooler gives you the flexibility to locate the water cooler where it's most needed
- Features large capacity and ample cup storage, plus an onboard trash receptacle for use with large plastic trash bags

WATER PRO

Includes station and trash bag frame.

- 3610** Hunter Green
- 3611** Black
- 3612** Redwood
- 3613** Caramel

Includes station, trash bag frame, 10 gal. (38 liter) Hunter Green Igloo® Water Cooler and Igloo® Cup Dispenser. 28 in. W x 22 in. D x 68 in. H (71 cm W x 56 cm D x 173 cm H)

- 3620** Hunter Green
- 3621** Black
- 3622** Redwood
- 3623** Caramel

Water Pro Accessories (Not shown)

- 3658** Igloo Cup Dispenser
- 3659** Case of 5,000 4 ½ oz. (126 ml) Cone-shaped Paper Cups
- 3657-1** Igloo Replacement Spigot (White)
- 7050** Safe-Tee Water™ Spigot (Black)



WATER PRO™ JR.

- Post-mounted water cooler station can be conveniently located virtually anywhere on the course
- Constructed of maintenance-free 100% recycled plastic material
- Features locking door with front access
- Mounting post is 6 in. x 6 in. x 72 in. (15 cm x 15 cm x 183 cm) recycled plastic



WATER PRO JR.

Includes Water Pro Jr. and black recycled plastic mounting post.

- 3626** Hunter Green
- 3627** Black
- 3628** Redwood
- 3629** Caramel

WATER PRO JR. COMPLETE

Includes Water Pro Jr., 10 gal. (38 liter) Igloo cooler, Igloo cup dispenser and one black recycled plastic mounting post.

- 3632** Hunter Green
- 3633** Black
- 3634** Redwood
- 3635** Caramel

IGLOO® WATER COOLERS

- 3657** Igloo Water Cooler, 10 gal. (38 liter) Hunter Green



- 3667** Igloo Water Cooler, 5 gal. (38 liter) Hunter Green



COOLER PRO

- A sleek, low-profile option for keeping refreshments cold on the course
- The Cooler Pro comes complete with a removable 48-qt. (36 liter) cooler
- 100% recycled plastic housing
- Includes a 48 qt. (36 liter) cooler
- Cooler lid attaches to Cooler Pro for convenience, or can be detached to use cooler separately
- 27 in. W x 18 in. D x 19 in. H (69 cm W x 46 cm D x 48 cm H)

- 3330** Hunter Green
- 3331** Black
- 3332** Redwood
- 3335** Caramel



RANGE BALL STORAGE BOX

- Sturdy, large capacity box holds up to 5000 golf balls
- Plastic slated bottom allows golf balls to vent and dry
- Lockable, dual-top opening for both secure storage and easy access
- Recycled plastic slats are fade-resistant and rustproof to endure extreme weather
- 39 in. W x 28 in. D x 27 in. H (99 cm W x 71 cm D x 69 cm H)

- 3350** Hunter Green
- 3351** Black
- 3352** Redwood
- 3353** Caramel



TEE PRO BALL WASHER



This unique ball washer design keeps a consistent look with the family of Par Aide recycled plastic products.

- Maintenance-free – no need to paint
- Uses same agitator and brush assembly as all Par Aide Ball Washers
- No tools needed to clean and fill
- Holds 1.5 gal. (5.7 liter) of water
- 24 in. x 14 in. x 13 in. (61 cm x 36 cm x 33 cm)
- Patented design

- | | |
|--------------------------|--|
| 3200 Hunter Green | 3250-00 Single-Post Mounting Kit – Black |
| 3201 Black | 3250-02 Single-Post Mounting Kit – Hunter Green |
| 3202 Redwood | |
| 3203 Caramel | |



BROKEN TEE BOX

A great addition to any tee box area, Par Aide's Broken Tee Box helps keep tee areas clean.

- Sits directly on ground. Legs allow for air flow
- Fade- and rust-resistant and maintenance-free
- Powder-coated expanded metal bottom
- 8 in. L x 10 in. W x 3 1/2 in. H (20 cm L x 25 cm W x 9 cm H)

- 3490** Hunter Green
- 3491** Black
- 3492** Redwood
- 3493** Caramel



SCORECARD CADDY

- Our Scorecard Caddy makes organization simple and can be customized for your course's needs
- Interchangeable dividers allow for custom organization of scorecards of all sizes, tees, pencils, ball markers and ball mark repair tools
- A great halfway house organizer for napkins, straws, matches, etc.
- Rustproof, fade-resistant and maintenance-free
- Hinged lid keeps contents dry
- Includes 4 in. x 4 in. post and bracket
- 10 1/2 in. x 19 in. x 4 1/4 in. (27 cm x 48 cm x 11 cm)

- 3358** Hunter Green, with Hunter Green post
- 3359** Hunter Green, with Black post
- 3360** Black, with Black post
- 3361** Redwood, with Black post
- 3362** Caramel, with Black post



SCORECARD CADDY ONLY

- 3358-2** Hunter Green
- 3358-0** Black
- 3358-11** Redwood
- 3358-12** Caramel

POST AND BRACKET ONLY (Not shown)

- 3358-1** Hunter Green
- 3359-1** Black
4 x 4 post and bracket only



Interchangeable dividers for custom organization.

The Superior Collection.

Anyone who has stood on the shores of Lake Superior in northern Minnesota cannot deny its beauty, power and ruggedness. These features are what have inspired our newest line of heavy-duty, maintenance-free recycled plastic products. Built from solid panel and recycled plastic lumber, these course accessories are strong, built to last and are as durable as they are attractive.

Customization options abound on many of the products in this collection. Choose from beautiful full-color resin dome inserts or one-color routed logos. Available in three vivid colors (black, brown and green) and two-tone options, our Superior Collection of recycled plastic products are a great way to give your course an instant makeover that will last for years to come.

TWO-TONE RECYCLED PLASTIC OPTIONS

With three vivid colors (black, brown and green), you can create a custom look throughout your course with many of the products in this collection.

CUSTOM LOGO OPTIONS

Choose from an engraved logo, filled with a one-color resin or a full-color acrylic dome logo with engraved outline.



NEW BACK BENCH

This 5.5 ft. (1.7 m) bench provides timeless style for years of use. Delivers excellent back support and features a gently angled seat for superior comfort.

- 620010** Black
- 620012** Brown
- 620014** Green



NEW TEE BENCH

This 5 ft. (1.5 m) classic bench is designed with a gently angled seat for greater comfort.

- 620000** Black
- 620002** Brown
- 620004** Green



NEW 5-GALLON SQUARE DIVOT MIX CONTAINER

This attractive and tough container keeps your divot mix dry and easily accessible.

- Custom logo available
- Stainless steel hinge
- Includes plastic scoop
- 12 in. H x 18 in. W x 12 in. D (30 cm H x 46 cm W x 30 cm D)

- 643250** Black
- 643252** Brown
- 643254** Green
- 643251** Black Panel/Brown Trim
- 643253** Green Panel/Black Trim



NEW 3.5-GALLON ROUND DIVOT MIX CONTAINER

Made of weatherproof recycled plastic with pointed slats for secure anchoring and a lid to keep sand dry.

- Includes removable plastic bucket and scoop
- 13 in. H x 14 in. D (33 cm H x 36 cm D)

- 643201** Black
- 643203** Brown
- 643205** Green



NEW ROUND TRASH CONTAINER

10- and 20-gallon capacity trash containers are built of heavy-duty recycled plastic to handle anything nature or golfers throw at them.

- Includes removable plastic liner
- Solid lids available

10-Gallon

21 in. H x 18 in. D (53 cm H x 46 cm D)

- 625500** Black
- 625502** Brown
- 625504** Green

20-Gallon

22 in. H x 22 in. D (69 cm H x 56 cm D)

- 625520** Black
- 625522** Brown
- 625524** Green



10-Gallon round shown

NEW RECYCLING DOUBLE TRASH

Our NEW Trash/Recycling bin is a beautifully designed container perfect for any facilities recycling needs.

- Custom logo available
- Constructed from recycled plastic and available in a variety of color options
- Open on all sides allows it to be placed in any location
- Hinged lid makes removing the two trash bags a breeze
- Includes two 13-gallon trash bag frames
- 35 in. H x 33 in. W x 18 in. D (90 cm H x 83 cm W x 46 cm D)

- 625667** Black
- 625666** Brown
- 625665** Green
- 625668** Black Panel/Brown Trim
- 625669** Green Panel/Black Trim



NEW SQUARE TRASH CONTAINER

Larger capacity 13- and 25-gallon, all-plastic trash containers feature an attractive full-panel design that's resistant to weathering.

- Custom logo available
- 13-gallon container includes trash bag frame
- 25-gallon container offers two options for trash collection: removable plastic liner or a trash bag frame

13-Gallon with Trash Bag Frame

28 in. H x 16 in. W x 16 in. D
(71 cm H x 41 cm W x 41 cm D)

- 625550** Black
- 625552** Brown
- 625554** Green
- 625551** Black Panel/Brown Trim
- 625553** Green Panel/Black Trim

25-Gallon with Plastic Liner

36 in. H x 20 in. W x 20 in. D
(91 cm H x 51 cm W x 51 cm D)

- 625571** Black
- 625573** Brown
- 625575** Green
- 625577** Black Panel/Brown Trim
- 625579** Green Panel/Black Trim

25-Gallon with Trash Bag Frame

- 625570** Black
- 625572** Brown
- 625574** Green
- 625576** Black Panel/Brown Trim
- 625578** Green Panel/Black Trim

Optional Recycled Trash Lids

- | 13-Gallon | 25-Gallon |
|---------------------|---------------------|
| 625557 Black | 625587 Black |
| 625558 Brown | 625588 Brown |
| 625559 Green | 625589 Green |



25-Gallon square shown

NEW FIVE STALL BAG RACK

- Custom logo available
- Each unit holds up to five bags
- Great for the clubhouse, range or bag room
- Can be used side by side, back to back or as a stand alone
- 32 in. H x 68 in. W x 17 in. D (81 cm H x 173 cm W x 43 cm D)

692120 Black
692122 Brown
692124 Green

Key Feature

Maximize your budget with value-priced recycled plastic.



NEW FOLDING BAG STANDS

- Custom logo available
- Folds for stacking or storage
- Available with or without cup holders
- Easy mobility allows effortless range placement
- Each bag stand includes two alignment sticks that sit in pre-drilled holes

Cup Holder

21 in. W x 26 in. H
 (53 cm W x 67 cm H)

692210 Black
692212 Brown
692214 Green

No Cup Holder

19 in. W x 26 in. H
 (49 cm W x 67 cm H)

692200 Black
692202 Brown
692204 Green

2 FREE ALIGNMENT STICKS WITH EVERY BAG STAND

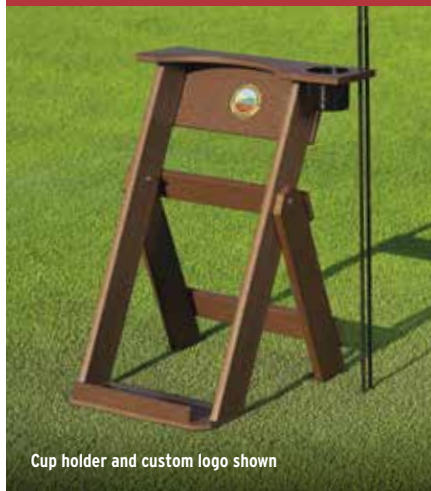

Cup holder and custom logo shown

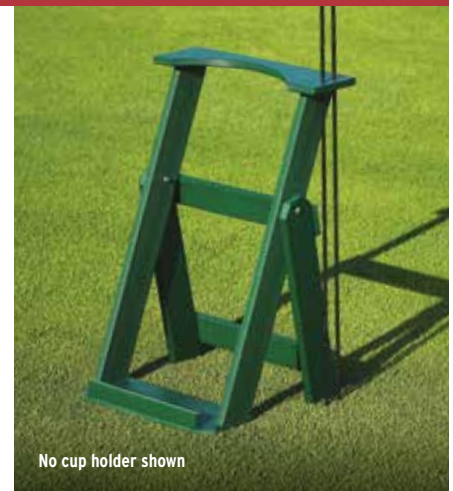

No cup holder shown

NEW BROKEN TEE BOX

- Keep tee areas tidy
- Recycled plastic sides with powder-coated steel mesh bottom
- 9 ½ in. x 7 ½ in. x 2 ½ in. (24 cm x 19 cm x 6 cm)

643400 Black
643401 Brown
643402 Green



NEW RANGE TEE DIVIDERS

- Easily manage your range tees with our attractive bay dividers
- Tough recycled plastic will withstand impacts from balls and clubs
- Includes spikes for anchoring
- 48 in. (1.2 m) length

Flat

- 692251** Black
- 692254** Brown
- 692256** Green

Upright

- 692250** Black
- 692253** Brown
- 692255** Green



Flat

Upright



Upright style shown

NEW ROUND CLUB WASHER

- Made of weatherproof recycled plastic with pointed slats for secure anchoring in turf
- Interior bucket has attached brushes that clean clubs effectively
- 18 in. H x 14 in. D (46 cm H x 36 cm D)

- 692270** Black
- 692271** Brown
- 692272** Green

692270-1 Club Washer Replacement Brush, Each Side



NEW SQUARE CLUB WASHER

- Custom logo available
- Recycled plastic club washer features beautiful full-panel design
- Interior bucket has attached brushes that are gentle on clubs while cleaning them quickly and effectively
- 19 in. H x 16 in. W x 16 in. D (48 cm H x 41 cm W x 41 cm D)

- 692280** Black
- 692281** Brown
- 692282** Green
- 692283** Black Panel/Brown Trim
- 692284** Green Panel/Black Trim

692270-1 Club Washer Replacement Brush, Each Side



NEW STARTER PODIUM

This starter podium features an attractive full-panel design and is highly weather resistant.

- Custom logo available
- Hinged top and large door provide multiple watertight storage options
- 45 in. H x 25 in. W x 21 in. D (114 cm H x 64 cm W x 53 cm D)

692150 Black

692152 Brown

692154 Green

692156 Black Panel/Brown Trim

692158 Green Panel/Black Trim

Umbrella Holder

692160 Black

692161 Brown

692162 Green

692159 Casters



NEW SAND DIVOT BOTTLE BOX

A beautiful full-paneled sand bottle storage box that is made of our durable recycled plastic. Box can hold up to twenty-four 40 oz. sand divot bottles and sits at an ideal height for golfers.

- Custom logo available
- Great storage option for range bags or range balls
- 30 in. H x 32 in. W x 23 in. D (76 cm H x 81 cm W x 23 cm D)

643300 Black

643301 Brown

643302 Green

643303 Black Panel/Brown Trim

643304 Green Panel/Black Trim



NEW WATER COOLER STATION

Side-loading water cooler and trash station is beautifully routed with a full-panel exterior and shingle-style roof.

- Custom logo available
- Compatible with a 5- or 10-gallon Water Cooler
- Trash options: a wire trash bag frame or a 20-gallon removable plastic liner
- 72 in. H x 25 in. W x 21 in. D (183 cm H x 64 cm W x 53 cm D)

20-Gallon Wire Trash Bag Frame

- 620520** Black
- 620522** Brown
- 620524** Green
- 620526** Black Panel/Brown Trim
- 620528** Green Panel/Black Trim

20-Gallon Plastic Liner

- 620521** Black
- 620523** Brown
- 620525** Green
- 620527** Black Panel/Brown Trim
- 620529** Green Panel/Black Trim



SAFE-TEE WATER™

Converting a cooler spigot to the Safe-Tee Water Fill-and-Dispense System is quick and easy.

- Cooler spigot needs a quick conversion to the Safe-Tee Water fill-and-dispense system pinch valve spigot
- Safe-Tee Water fill-and-dispense system is designed to work with 10-gallon insulated coolers
- Fill system consists of a coupler that attaches to a dedicated water supply, a hose and an adapter that connects to the liner's fill tube
- Safe-Tee Water spigots are ordered separately
- Safe-Tee Water spigots fit on the most common brands of coolers, easily replacing the original spigots
- One-use sanitary liners are available in quantities of 200



NEW WATER COOLER TRIPOD

A 5- or 10-gallon Igloo® Water Cooler can be enclosed in this tough, maintenance-free water station. 60 in. H x 20 in. D (152 cm H x 51 cm D)

- 620500** Black
- 620502** Brown
- 620503** Green



Fill System

7100 Includes Coupler, Hose and Adapter



Sanitary Liners

One-Use Liners
7150 Case of 200

Safe-Tee Water Spigot

7050



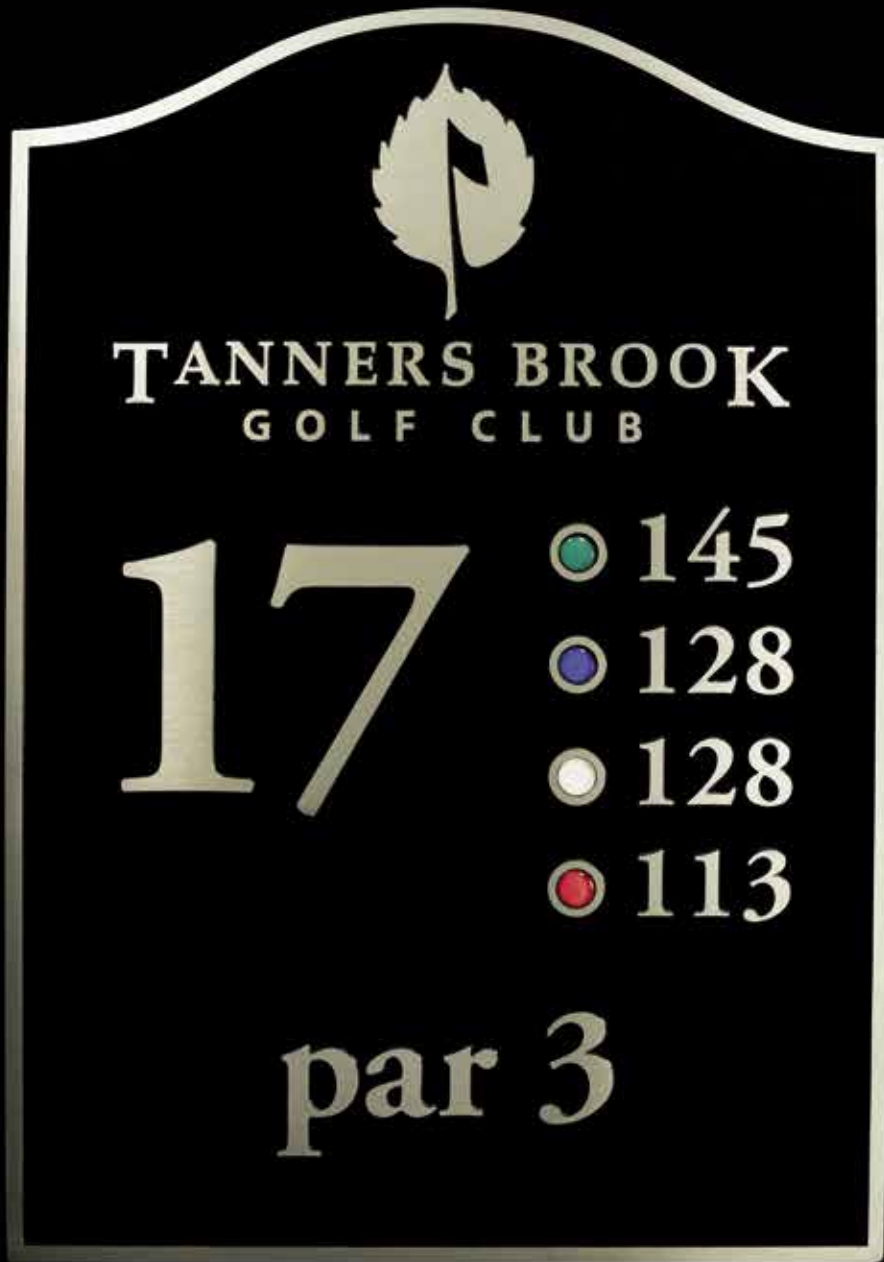

COURSE MARKINGS



The ultimate sign of quality.

Nothing helps elevate the perception of course status more than cast metal course signage. But the prohibitive cost of foundry-produced cast signage can be out-of-bounds for most. Now with Par Aide's line of FusionCast signage, aluminum or bronze metal signs, plaques and markers are within reach.

Our FusionCast signage uses a patented technology that fuses metal with high density urethane (HDU), resulting in dimensional plaques and markers that look, feel and perform like foundry-poured signs, but without the excessive weight and high production costs.

This unique cold-casting technology also lets us create highly detailed customized signs. Emblazon your brand onto tee markers and plaques, in-ground tee and fairway yardage plaques, cart path pyramids, sponsor signs, facility wayfinding signs and tee signs. Every FusionCast sign is available in aluminum or bronze and adds an elegance that enhances the brand of your facility.

Par Aide FusionCast markers and signs are available in a range of stock template shapes, sizes and mounting configurations. Best of all, our FusionCast signs are proven to perform exceptionally in the harshest climates, providing the richness and rugged durability you expect from high-quality metal signage.

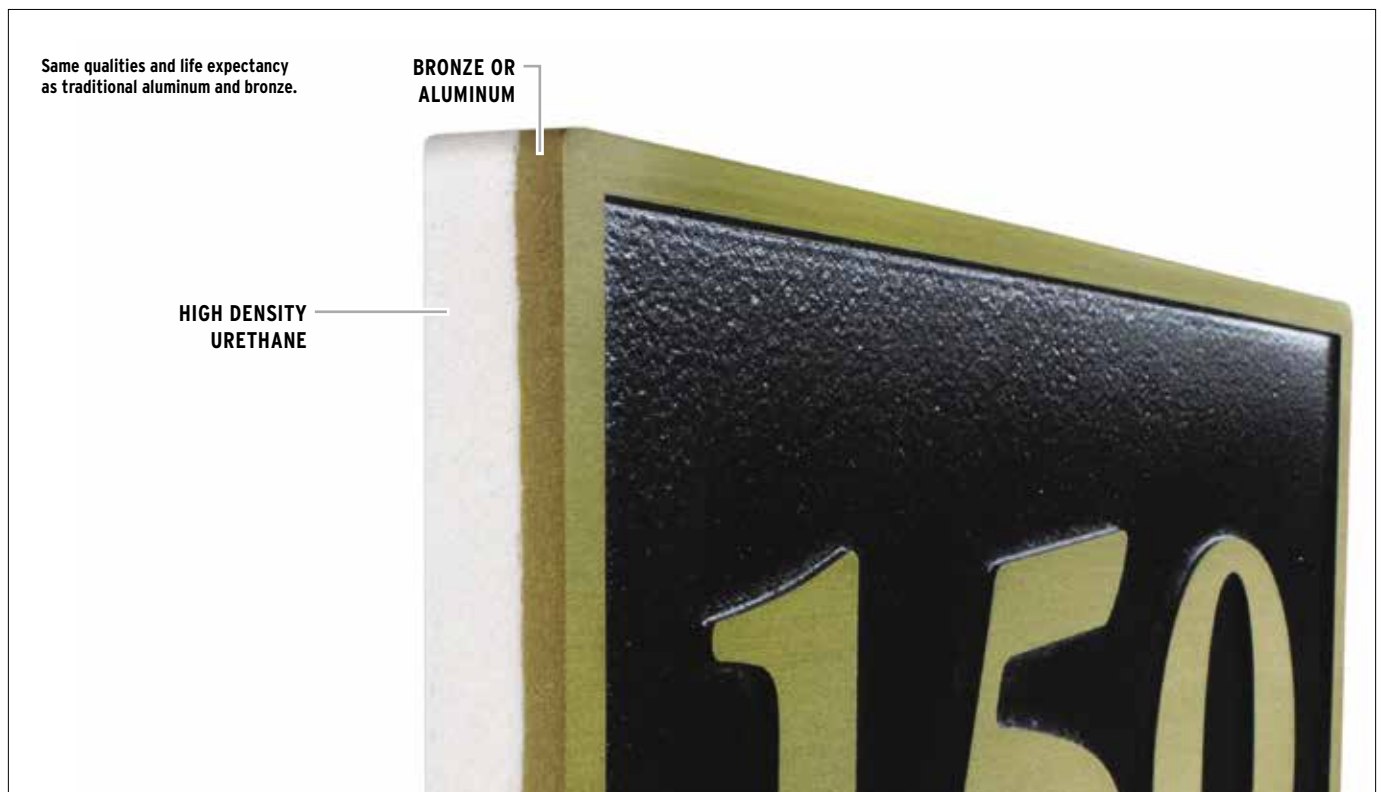

FusionCast® TEE SIGNS

Our tee signs are the perfect way to enhance the branding of your course on each tee box. These products are completely customizable to the detailed specifications of your course creating endless possibilities including:

- Custom tee yardages
- Full color domed or sleek cast metal logos
- Domed hole layouts
- Aluminum or bronze metal

TEE SIGN SHAPES (Shown on right)

- Arc
- Crown
- Rectangle

TEE SIGN SIZES

- 12 in. x 18 in. (30 cm x 46 cm)
- 14 in. x 20 in. (36 cm x 51 cm)
- 16 in. x 22 in. (41 cm x 56 cm)
- 18 in. x 24 in. (46 cm x 61 cm)



Arc shape



Crown shape



Rectangle shape

Begin the design process at ParAide.com or contact distributor for a quote.
 Custom shapes and sizes available. Contact us for more information.



FusionCast® SPONSOR SIGNS

A great opportunity for your membership or surrounding community to advertise their business or service in an elegant and impactful way. It's also a great opportunity to help cover or subsidize the cost of your tee sign project with the potential to eventually develop into a revenue driving feature for your course in future years!

Sponsor signs can be made to perfectly match the specifications of your new or existing FusionCast tee signs.

SPONSOR TEE SIGN SIZES

- 12 in. x 6 in. (30 cm x 15 cm)
- 14 in. x 7 in. (36 cm x 18 cm)
- 16 in. x 8 in. (41 cm x 20 cm)
- 18 in. x 9 in. (46 cm x 23 cm)

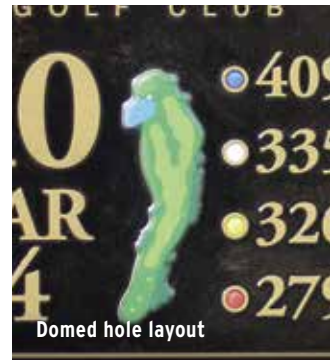

FusionCast® LOGO AND HOLE LAYOUT OPTIONS

Whether it's your course logo or a company logo for your sponsor signs, we have two options that work great for most FusionCast products. The sleek cast metal logo offers a uniform look in the popular aluminum or bronze metal options. If you are looking for a full color logo, our super durable and weather resistant domed acrylic logos give your FusionCast signs a look that pops. Further customize each tee sign with a detailed, full color hole layout with our acrylic domes. Another great feature and gives golfers an aerial view of each hole.

LOGO OPTIONS

- Cast Metal Logo
- Domed Acrylic Logo

HOLE LAYOUT

- Domed Acrylic Hole Layout

Begin the design process at ParAide.com or contact distributor for a quote.
Custom shapes and sizes available. Contact us for more information.

FusionCast®
WAYFINDING SIGNS

Every course needs directional signage. Facility entrance signs, on course wayfinding signs, clubhouse signage and more. Elevating your directional signage with our revolutionary FusionCast technology instantly enhances golfers experience and the branding of your course.

Similar to our tee signage, each wayfinding sign can be customized to perfectly fit its placement on your course and is available in a variety of shapes, sizes or metal.

WAYFINDING SIGN SHAPES

- Arc
- Crown
- Rectangle

WAYFINDING SIGN SIZES

- 12 in. x 18 in. (30 cm x 46 cm)
- 14 in. x 20 in. (36 cm x 51 cm)
- 16 in. x 22 in. (41 cm x 56 cm)
- 18 in. x 24 in. (46 cm x 61 cm)



Begin the design process at ParAide.com or contact distributor for a quote.
Custom shapes and sizes available. Contact us for more information.

FusionCast® TEE MARKERS

Custom Tee Markers are our specialty with the patented FusionCast technology. We can produce tee markers for you in any shape, color or logo you desire! Like all FusionCast products, custom cast tee markers are a terrific opportunity to effectively brand your course.

- Single or double sided available
- Four stock shapes: oval, round, square or rectangle
- Custom shapes available upon request
- Order from our stock template shapes for quickest turn time and best pricing



Domed full color logo



FusionCast® CART PATH YARDAGE PYRAMIDS

- Pyramids with mounting hardware included
- 9 in. x 5 ¼ in. (23 cm x 13 cm)
- Available in 100, 150, 200, 250 yardages

Aluminum

- 5192-1 100
- 5194-1 150
- 5196-1 200
- 5198-1 250

Bronze

- 5192-2 100
- 5194-2 150
- 5196-2 200
- 5198-2 250



Begin the design process at ParAide.com or contact distributor for a quote.
 Custom shapes and sizes available. Contact us for more information.

**FusionCast® IN-GROUND
TEE & FAIRWAY YARDAGE
MARKERS**

Nothing speeds pace of play like well-marked yardage on your tees and fairways. Adding your course logo to Par Aide's FusionCast in-ground markers dramatically enhances the aesthetics of your course. Any yardage or color available.

IN-GROUND YARDAGE MARKERS

- 5 in. x 7 in. (13 cm x 18 cm)
- 6 in. x 8 in. (15 cm x 20 cm)
- 8 in. x 10 in. (20 cm x 25 cm)
- 10 in. x 12 in. (25 cm x 30 cm)
- 6 in. (15 cm) Round



Begin the design process at ParAide.com or contact distributor for a quote.
Custom shapes and sizes available. Contact us for more information.

HOW TO ORDER FusionCast®

Every FusionCast product is custom-made to order. Prior to requesting a quote from your Par Aide distributor or visiting ParAide.com to start your quote, make sure to take the following step by step process to expedite the design/quote process. To help guide you through these steps, we have created an interactive quoting tool on our website. Visit www.ParAide.com/fusioncastquote

STEP 1 - OBTAIN

- High resolution artwork of your course logo (preferably vector art)

STEP 2 - IDENTIFY

- The FusionCast product(s) that you are looking to order
- The metal you wish your products to be (aluminum or bronze)

STEP 3 - CHOOSE

- The **SHAPE** of your signage or marker
- The **SIZE** of your signage or marker
- The **LOGO OPTION** for your products (cast logo or full color domed acrylic)
- The **BORDER STYLE** (Single Line or Inset Single Line)
- The **BACKGROUND COLOR** for your products
- The **MOUNTING OPTION** if applicable

STEP 4 - SELECT

- The Par Aide distributor to use to facilitate the quote and order through Par Aide

MOUNTING OPTIONS

FusionCast signs can be mounted on our 8 ft. aluminum 3 in. x 3 in. post with an attractive Newel cap. This post height ensures that it's placed deep enough in the ground for ultimate stability. From there, you can select any of our three popular mounting options for your signage. Shorter posts are available for all your course signage needs.



BORDER OPTIONS

Aluminum or Bronze

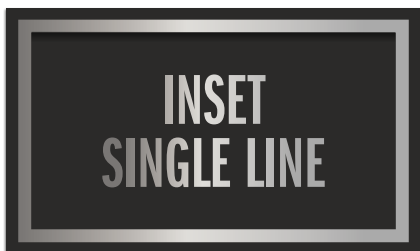
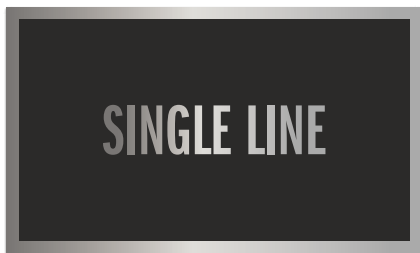

BACKGROUND COLOR OPTIONS

Aluminum or Bronze



FusionCore™

Our new line of FusionCore products is your most ECONOMICAL, DURABLE and VERSATILE option when it comes to custom course signage. FusionCore is a multi-layered polymer sign available in a number of different color combinations giving you countless options for your directional signage, tee signage, fairway plaques and more. The polymer used in FusionCore is incredibly durable and able to withstand the physical rigors and external environments of your golf course. FusionCore signs won't rot, de-laminate or warp, making them ideal for a variety of indoor and outdoor applications.

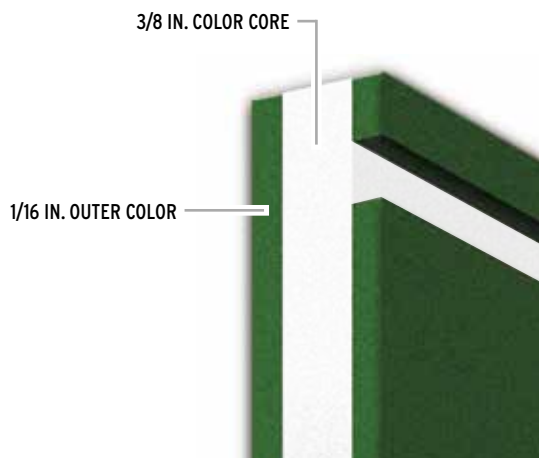

FusionCore™ TEE MARKERS

Custom FusionCore tee markers are the easiest and most affordable way to add style and distinction throughout your golf course. Add your logo to stock shapes (round, oval, square, rectangle) or create your own custom shape tee marker for the ultimate in course branding.

NEW

Visit ParAide.com for more information or contact distributor for a quote



FusionCore™ TEE SIGNAGE

Give your tee complexes a beautiful upgrade without breaking the bank. Adding new FusionCore tee signs is a very affordable way to instantly enhance the look and functionality of your golf course. These attractive signs are fully customizable with the ability to add your course logo, hole layouts, yardages and more. Choose from one of our stock template sizes/shapes or create your own unique look with a fully custom sign.

NEW Visit ParAide.com for more information or contact distributor for a quote

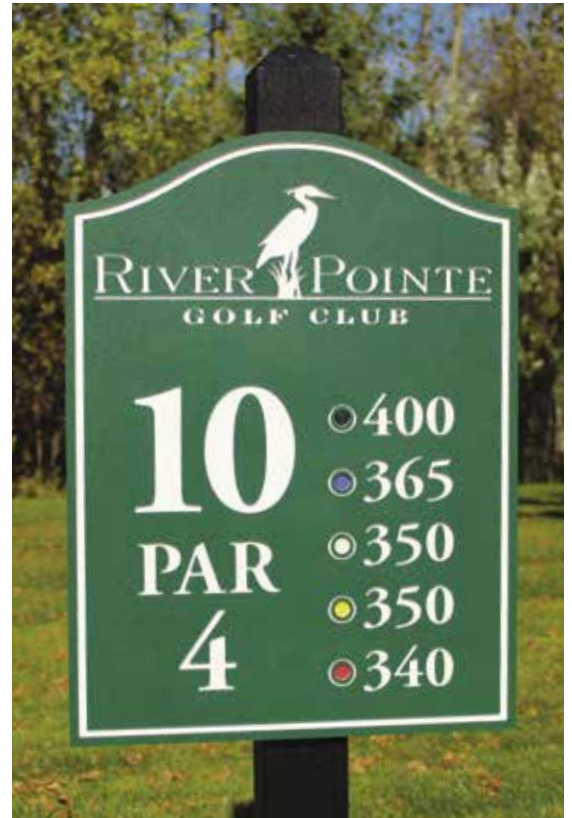

FusionCore™ COURSE SIGNAGE

Whether by the clubhouse, practice facility or on the course, proper signage is essential to give your golfers the appropriate information they need to navigate through your facility. Well placed course signage not only helps speed up play, but also adds to the golfer's experience and enhances the brand of your facility. Your options are vast and incredibly affordable when it comes to course signage with our line of FusionCore products.

NEW Visit ParAide.com for more information or contact distributor for a quote



NEW FusionCore™ DIRECTIONAL SIGNS

Our ½ in. thick, 12 in. x 6 in. FusionCore Directional Signs are your best, most durable option for every day course signage.

- Stainless steel spikes
- 12 in. x 6 in. (30 cm x 15 cm)
- ½ in. (1 cm) thick

Green

- 681000** Ground Under Repair
- 681001** Tee Area Closed
- 681002** Keep Carts on Path
- 681003** Drop Area
- 681004** Drop Zone
- 681005** Putting Green Closed
- 681006** Carts >
- 681007** Next Tee >
- 681008** Observe 90° Rule
- 681009** No Carts
- 681010** Native Area
- 681011** Native Area No Carts
- 681012** Please Repair Ball Marks
- 681013** No Carts Past Here
- 681014** No Chipping
- 681015** < Carts
- 681016** < Next Tee

681018 Carts > (Double-sided)



NEW 1/4 IN. (1 CM) DIRECTIONAL SIGNS

These laminate signs are routed, weather resistant, extremely durable and affordable.

- 1 piece with routed spike
- 10 in. x 5 ½ in. (25 cm x 14 cm)
- ¼ in. (1 cm) thick

Green **Yellow**

- | | |
|---------------|---|
| 681100 | 681200 Ground Under Repair |
| 681101 | 681201 Tee Area Closed |
| 681102 | 681202 Keep Carts on Path |
| 681103 | 681203 Drop Area |
| 681104 | 681204 Drop Zone |
| 681105 | 681205 Putting Green Closed |
| 681106 | 681206 Carts > (Double-sided) |
| 681107 | 681207 Next Tee > (Double-sided) |
| 681108 | 681208 Observe 90° Rule |
| 681109 | 681209 No Carts |
| 681110 | 681210 Native Area |
| 681111 | 681211 Native Area No Carts |
| 681112 | 681212 Please Repair Ball Marks |
| 681113 | 681213 No Carts Past Here |
| 681114 | 681214 No Chipping |





Indestructible course communications.

Our exclusive Dura-Flex Signs survive years of punishment from wayward carts and whatever else your course can dish out. Thick, flexible and maintenance-free material with raised 3D lettering and a molded-in continuous spike. A wide selection of standard messages and colors are available.

PA Par Aide Exclusive

Unbreakable sign with stainless steel spikes that cannot pull out.

DURA-FLEX

- 3-D molded-in letters means printing will not scratch off
- Corrosion-resistant spikes are formed by a single U-shaped, stainless steel rod molded into the resin for maximum strength
- Flexible design makes them virtually indestructible
- Clear-coated for fast and easy cleaning
- Large, easy-to-read lettering
- Available in popular color options
- 10 ½ in. x 5 ½ in. (27 cm x 14 cm) (not including spike)



Designed to flex



Unique U-shaped spike(s)

DURA-FLEX SIGNS

- 5610-__ White with Hunter Green letters
 - 5620-__ Hunter Green with White letters
 - 5630-__ Yellow with Black letters
- Specify caption, see list below.

Captions available:

- 01 "Ground Under Repair"
- 02 "Tee Area Closed"
- 03 "No Carts Past Here"
- 04 "Keep Carts On Path"
- 05 "Please Rake Bunkers"
- 06 "Please Repair Ball Marks"
- 07 "Drop Area"
- 08 "Wet Area Carts Keep Off"
- 09 "Please Replace Divots"
- 10 "Please Keep Off"
- 11 "Carts Scatter"
- 12 "Putting Green Closed"
- 13 "No Chipping"
- 14 "Next Tee ^"
- 16 "No Carts"
- 17 "< Carts"
- 18 "Carts >"
- 19 "< Next Tee"
- 20 "Next Tee >"
- 21 "Please Observe 90° Rule"
- 22 "Trolleys >"
- 23 "< Trolleys"
- 24 "No Trolleys"
- 25 "Drop Zone"





WOOD DIRECTIONAL SIGNS

- Give your golf course a timeless, traditional look with our new hardwood signs
- Each sign is individually hand-oiled to maintain a rich, hardwood color
- Can be easily refurbished by applying teak oil
- Letters are routed and painted
- Stainless steel spikes
- 10 3/8 in. x 5 3/8 in. x 3/4 in. (26 cm x 14 cm x 2 cm)

Captions available:

- | | |
|---|---------------------------------------|
| 5660-01 "Ground Under Repair" | 5660-10 "Next Tee >" |
| 5660-02 "Tee Area Closed" | 5660-11 "Observe 90° Rule" |
| 5660-03 "Keep Carts On Path" | 5660-12 "No Carts" |
| 5660-04 "No Carts Past Here" | 5660-13 "Native Area No Carts" |
| 5660-05 "Please Repair Ball Marks" | 5660-14 "No Chipping" |
| 5660-06 "Drop Area" | 5660-15 "Drop Zone" |
| 5660-07 "Putting Green Closed" | 5660-16 "< Carts" |
| 5660-08 "Please Keep Off" | 5660-17 "< Next Tee" |
| 5660-09 "Carts >" | |

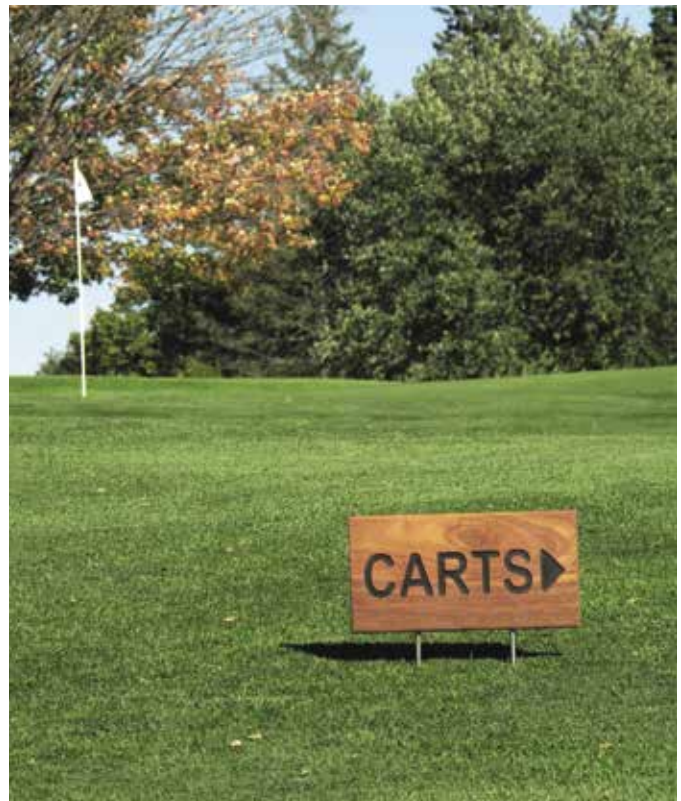

Double-sided signs available. Contact Par Aide distributor for details.



PAR 3 DISTANCE SIGN

Give golfers the exact distance to the hole from each tee with this gorgeous wood sign. Place it at the cart path, near the bottom of a hill or right next to your tee markers. Whichever you choose, you will be reducing golfers pace of play by assisting in their club selection prior to approaching the tee!

- Give your golf course a timeless, traditional look with our new hardwood signs
- Adjustable numbers available in black and white laminate plastic
- Each sign is individually hand-oiled to maintain a rich, hardwood color
- Stainless steel spikes
- 10 3/8 in. x 5 3/8 in. x 3/4 in. (26 cm x 14 cm x 2 cm)

5380 Sign Only (Number Packs Ordered Separately)



Par 3 Distance Sign Number Packs*

5380-0 "0"	5380-5 "5"
5380-1 "1"	5380-6 "6"
5380-2 "2"	5380-7 "7"
5380-3 "3"	5380-8 "8"
5380-4 "4"	5380-9 "9"

*Sold in Packs of 4.

MARKING PAINT

The key to marking paint lies in the right nozzle design, which controls the density, brightness and length. Ours provides the perfect combination of distance and visibility. Try it out and see the difference for yourself.



Par Aide Turf Marking Paint (bottom) is brighter, more visible than competitor's (top).

MARKING PAINT*

Bolder lines, better for turf.
Sold in cases of 12 cans.

12410 White, 18 oz. (510 g) can

12411 Red, 17 oz. (482 g) can

12412 Yellow, 17 oz. (482 g) can

12413 Blue, 17 oz. (482 g) can

12414 Cover-Up Green, 17 oz. (482 g) can

12415 Fluorescent Orange, 17 oz. (482 g) can

*Ground shipping only.



PAINT APPLICATOR

Apply paint lines to turf surfaces faster, easier and straighter without kneeling or stooping. Our paint applicator trigger wand lets you apply continuous lines easily around hazards, out-of-bounds, drop areas and ground under repair. Lightweight and easy to maneuver. Approximately 35 in. (89 cm) long.

12401



DOUBLE BARREL PAINT GUN

Paint bolder, more noticeable lines around your hazards and out of bounds. The Double Barrel Paint Gun angles the paint cans slightly to focus the spray for highly visible lines. A great tool when preparing for tournaments.

12403



GREEN & WHITE™ DIRECTIONAL MARKERS

Easy to place and remove, these multipurpose markers are extremely helpful for guiding golfers in the right direction around the course.

- Maintenance-free
- Durable 8 in. (20 cm) recycled plastic White stakes with a 4 in. (10 cm) Hunter Green, Red, Black or Blue vinyl cap
- Sturdy stainless steel spike measures 5/16 in. (1 cm) in diameter
- Versatile – direct cart and foot traffic, protect wet areas and new sod, place in front of greens, etc.
- Sold in quantities of 25; includes a carrying/storage bucket
- Bucket keeps product clean and easy to transport



Key Feature
Extremely versatile traffic control system.

GREEN & WHITE DIRECTIONAL MARKERS

8 in. (20 cm) sold in buckets of 25 only.

- 12250-25** Hunter Green & White
- 12251-25** Red & White
- 12252-25** Black & White
- 12253-25** Blue & White



Mark off repair areas.



Encourage traffic to exit cart paths in different locations to reduce wear patterns.



Discourage golf cart traffic on grass edges.



Discourage golf cart traffic in wet areas/ground under repair.



HAZARD & OB MARKERS

- Maintenance-free, fully color-impregnated, recycled plastic
- Extremely fade-resistant
- Sturdy, 5/16 in. (1 cm) stainless steel spike

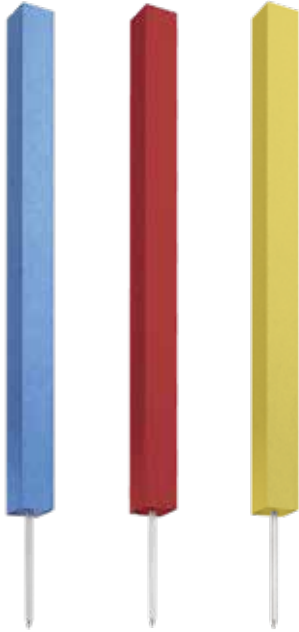

HAZARD MARKERS – SPIKE

Boxes of 25 – Best Value

- 11430-25** 18 in. (46 cm) Red
- 11433-25** 18 in. (46 cm) Yellow

- 11436-25** 24 in. (61 cm) Red
- 11437-25** 24 in. (61 cm) Blue
- 11439-25** 24 in. (61 cm) Yellow

HAZARD MARKERS – POINTED

Boxes of 25 – Best Value

- 11466-25** 24 in. (61 cm) Red
- 11469-25** 24 in. (61 cm) Yellow

OB MARKERS

Boxes of 25 – Best Value

Spike

- 11618-25** 18 in. (46 cm) White

- 11620-25** 24 in. (61 cm) White

- 11623-25** 34 in. (86 cm) White

Pointed

- 11642-25** 30 in. (76 cm) White

Individual stakes are available for an additional cost.



All stakes feature rustproof stainless steel spikes.



BRAIDED POLY ROPE

Our ¼ in. (1 cm) braided poly rope is available in 1,000 ft. (304.8 m) spools and comes in assorted colors, including Hunter Green, custom formulated to blend with the Hunter Green rope stakes.

- 12950** Yellow
- 12954** White
- 12956** Black

- 12958** Hunter Green
- 12962** Hunter Green/White

ROPE STAKES

Rope stakes feature angled slots to easily add or remove rope. Also available in White. Boxes of 25 – Best Value

- 12200-25** 12 in. (31 cm) Hunter Green
- 12210-25** 18 in. (46 cm) Hunter Green
- 12213-25** 18 in. (46 cm) Black
- 12214-25** 18 in. (46 cm) Brown
- 12230-25** 24 in. (61 cm) Hunter Green

Individual stakes are available for an additional cost.

ROPE FID

Allows user to attach rope around rope stake without tying a knot. Creates a clean-looking loop that will hold tight to the rope stake.

1037



VINYL-COVERED FAIRWAY POLE

Our vinyl-covered yardage poles are engineered for superior durability and visibility. They are a great choice for marking the center of the fairway, 150 yds. or other distances, or for indicating the edge of a hazard.

- Vinyl covering protects against fading, cracking, scratching and damage from UV rays, chemicals and the elements
- Pre-assembled with in-ground mounting included
- Superior visibility makes club selection easier for golfers



FAIRWAY AND HAZARD POLES

- PVC pole with vinyl covering
- Includes PVC ground anchor for mounting
- 2 in. (5 cm) diameter, 60 in. (1.5 m) tall

- 11680** Black & White stripe
- 11681** Red & White stripe

Key Feature

Withstands being struck by golf balls better than painted PVC pipe.

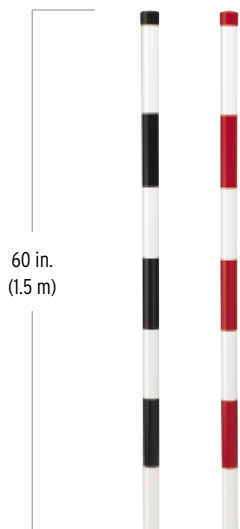

LAMINATE FAIRWAY DISTANCE MARKERS

- Dependable and economical yardage marker for your course
- 11 in. (28 cm) marker features routed numbers
- Includes stainless steel spike to secure marker
- Reliable and weather-resistant
- ½ in. (1.3 cm) thickness



6 in. (15 cm)

- 5330** Red
- 5331** White
- 5332** Blue
- 5333** Black
- 5334** Yellow



6 in. (15 cm)

11 in. (28 cm)

- 5300** Red 100
- 5301** White 150
- 5302** White 200
- 5303** Blue 200
- 5304** Blue 250
- 5305** Black 250
- 5306** Yellow 150



11 in. (28 cm)

NEW EZ SEE™ DISTANCE MARKERS

- The patented EZ See distance marking system is the best mow-over style available
- The 11 in. (28 cm) markers are available in four colors
- Can be mowed over in any direction
- Simple, subtle and appealing design
- Easy to locate when needed
- 3/8 in. (1 cm) diameter



Complete Marker

- 680900** Red
- 680901** White
- 680902** Blue
- 680903** Yellow

Replacement Upright

- 680910** Red
- 680911** White
- 680912** Blue
- 680913** Yellow

Key Feature

Save time with mow-over markers.

[View product demo at ParAide.com](#)

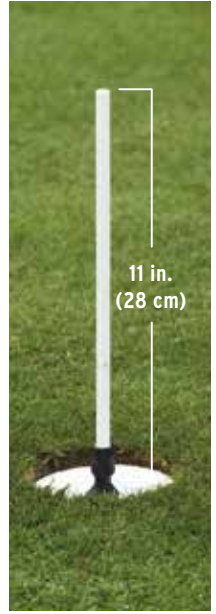

NEW COURSE ACCESS FLAGS

Replace unsightly industrial clips with our Course Access Flags, which feature a discreet steel mounting bracket to prominently display special access flags on golf course grounds.

Course Access Flags Include:

- Sturdy, universal, powder-coated steel bracket that fits on any corner of golf cart uprights
- Two 1 in. (3 cm) Velcro® straps hold bracket securely in place
- Durable 1/2 in. (1.3 cm) fiberglass rod
- Highly visible 5 in. x 8 in. (13 cm x 20 cm) 400 Denier flag

- 678750** Handicap
- 678751** Ranger
- 678752** Player Assistant
- 678753** Rules Official



Powder-coated steel bracket



Adjustable bracket that fits most golf carts

NEW CART DIRECTIONAL BARRIER

Direct golf carts to minimize traffic on vulnerable turf. 4 in. x 4 in. x 48 in. (10 cm x 10 cm x 122 cm)

- 681900** Black
- 681902** Brown
- 681904** Green





GREENS TOOLS

ESTD



1955

ORIGINAL HOLE CUTTERS

Two great solutions to make precise hole cutting easier. Try our Original Lever Action Hole Cutter's back-saving design for effortless plug extraction. Or with our Foot Extraction Hole Cutter, simply step down on the foot plate to extract the turf plug.

LEVER ACTION

- 1001-1** With Scalloped Blade, Inside Edge
- 1001-2** With Scalloped Blade, Outside Edge
- 1001-3** With Straight Blade, Inside Edge
- 1001-4** With Straight Blade, Outside Edge

- 1001-19** With Scalloped Blade, Inside Edge and Bubble Level
- 1001-29** With Scalloped Blade, Outside Edge and Bubble Level
- 1001-39** With Straight Blade, Inside Edge and Bubble Level
- 1001-49** With Straight Blade, Outside Edge and Bubble Level



FOOT EXTRACTION

- 1002-1** With Scalloped Blade, Inside Edge
- 1002-2** With Scalloped Blade, Outside Edge
- 1002-3** With Straight Blade, Inside Edge
- 1002-4** With Straight Blade, Outside Edge

- 1002-19** With Scalloped Blade, Inside Edge and Bubble Level
- 1002-29** With Scalloped Blade, Outside Edge and Bubble Level
- 1002-39** With Straight Blade, Inside Edge and Bubble Level
- 1002-49** With Straight Blade, Outside Edge and Bubble Level



Key Feature

Heat treated blades keep edge longer.

ORIGINAL HOLE CUTTER BLADES

Our Hole Cutter Blade allows you to cut and set your cup deeper. USGA rules state that a cup must be set a minimum of 1 in. (3 cm) below the surface of the green.

Hole Cutter Blade, 7 1/2 in. (19 cm) Plain

- 1007-01** Inside Sharpened Edge
- 1007-02** Outside Sharpened Edge

Hole Cutter Blade, 7 1/2 in. (19 cm) Scalloped

- 1008-01** Inside Sharpened Edge
- 1008-02** Outside Sharpened Edge

HOLE CUTTER REPLACEMENT PARTS (Not shown)

Hole Cutter Piston
1016

Lever Arm only
1020

Push Rod only
1021

Wooden Handle for Hole Cutter
1022

Wooden Handle for Hole Cutter with Built-in Bubble Level
1029
Hardwood handle with a recessed bubble level. Optional item for all Par Aide hole cutters and fits most major brands.

Go to ParAide.com for replacement parts not shown.

INSIDE SHARPENED VS. OUTSIDE SHARPENED



Inside sharpened: sand-based



Outside sharpened: push up native soil



HiO HOLE CUTTER

The art of hole cutting taken up a notch. The best pound-in hole cutter on the market, the HiO Hole Cutter, offered exclusively by Par Aide. Superintendents everywhere have been won over by its precision, ease-of-use and time and body-saving ability. To operate, simply pull out the pin, lift the handle, and the hammer action drives it into the ground.

Enjoy the following advantages:

- Perfectly round holes with clean edges
- Easy on arms and shoulders – no twisting required
- Powerful action works great on clay-based “push up” greens
- Perfect for Bermuda greens, as grain direction is easily matched when replacing plugs
- Easy for any crew member to operate
- Achieve uniform hole depth
- Single-cut holes save time



HiO HOLE CUTTER



With its patented design, the HiO Hole Cutter means perfectly cut cups that keep greens looking great and playing true, all while saving you time and effort.

- 1003-1** HiO inside sharpened blade (sand-based, USGA greens)
- 1003-2** HiO outside sharpened blade (native soil “push up” greens)

- 1009-01** HiO inside sharpened replacement blade (sand-based, USGA greens)
- 1009-02** HiO outside sharpened replacement blade (native soil “push up” greens)

 [View product demo at ParAide.com](https://www.ParAide.com)



Inside sharpened blade suggested for sand-based and USGA greens.



Outside sharpened blade suggested for “push up” and native soil.

PA Par Aide Exclusive

Patented HiO Hole Cutter cuts perfect holes and saves time.



1 Place HiO Hole Cutter in desired cup location.

2 Remove pin. Lift handle and hammer action drives cutter into the ground.

3 HiO Hole Cutter cuts holes with one plug, every time.

4 HiO Hole Cutter leaves a perfectly round, clean hole.



HiO BUBBLE LEVEL

This optional item for the HiO Hole Cutter ensures a straight cup every time. It fits all existing HiO Hole Cutters by simply attaching through the two bolts that hold the handle in place.

1028



DEPTH GAUGE

Unique single-set screw design allows for easy locating, straightening and tightening. Cast aluminum and anodized black, fits all hole cutters.

1034

Rubber Grip

1003-9 (Pair)

Two-Piece Steel Handle

1003-21 (Hardware & grips included)

Locking Pin, Spring & Ball Kit

1003-22

Outer Tube

1003-7 (Complete)

Ejecting Handle

1003-8 (Complete)

Rope

1003-17

Rubber Ring

1003-13

Ejecting Rod

1003-10 (Complete)

Cleat

1003-16

Inner Tube

(Not shown)
1003-25 (Complete)

Piston

(Not shown)
1017 (Complete)

Stop Ring & Pin Kit

(Not shown)
1003-23



Go to ParAide.com for replacement parts not shown.





NEW CENTER SET CUP SETTER

The Center Set Cup Setter will not scratch or mark painted cups, and it helps eliminate cracked and damaged edges of your cups. The center rod can be adjusted to accurately set cups at the precise depth.

655622



CUP SETTER

Cast aluminum with powder-coated White finish. The Cup Setter sets cups an extra $\frac{1}{8}$ in. ($1\frac{1}{8}$ in. total) below the surface of the green. USGA rule states that the putting cup must be set at a *minimum* depth of 1 in. This feature ensures that you meet that requirement.

1031  **Key Feature**
Sets cups an extra $\frac{1}{8}$ in. deep to ensure sufficient depth.



CUP PULLER

Features long rod and rubber handle for maximum leverage and comfort. Plated steel construction. Three-hook design pulls cup out of hole straight with ease and with no damage to turf.

1032



CUP HOLE CLEANER

All-steel construction. Designed to prevent unsightly dirt stains on green by removing water from hole when changing cups, before inserting turf plug. Just remove cup, insert cup hole cleaner, press down slowly forcing water into unit, and remove. No more mess on green or pants.

950



HOLE CUTTER GUIDE

Made from highly durable ABS plastic. 23 in. x 19 in. (58 cm x 48 cm). Place on green when cutting cup hole to eliminate heel marks, minimize raised hole edges and encourage a straight cut.

1030



NEW CUP HOLE TRIMMING SCISSORS

Our new Cup Hole Trimming Scissors are the ultimate tool for maintaining the perfect, most precise cup hole edge. The curved blade makes trimming around a cup hole easy and accurate, leaving a beautiful and crisp edge.

1036



NEW

MILTONA CUP AUGER™

Take the next step in cup changing. The Cup Auger is for those who want to go above and beyond to ensure their cups are set perfectly. Using this tool is the best way to achieve consistent cup depth on every green, no matter who is doing the job.

Use the Cup Auger for perfect cup depth every time.

1. Place a depth ring on your cutting shell at 6 7/8 in. (17 cm)
2. Set the Cup Auger collar at the regulation depth of 7 in. (18 cm)
3. Cut a new hole to the depth of the ring.
4. Use the Cup Auger to perfectly finish the hole.
5. When your cup is set, it will rest exactly at the required depth.

655661



 [View product demo at ParAide.com](https://www.paraide.com)



HOLE CUTTER MOUNT

Keep your hole cutter within easy reach while saving space in your vehicle. It can be mounted on virtually any vehicle, allowing upright or angled transport of any hole cutter. The mount also protects the blade and body, while keeping your vehicle more organized. Durable steel construction with mounting hardware included.

1011



 **Par Aide Exclusive**

Stay organized and protect your hole cutter blades.



CREW CADDY™ & HOLE CUTTER MOUNT

When it's time to grab your tools and get to work, let Par Aide's innovation go to work for you. Our Crew Caddy conveniently organizes your greens tools, keeping everything within reach. Our Hole Cutter Mount frees up valuable space in your cart while protecting the hole cutter. Count on Par Aide to help you get organized.

CREW CADDY

Saves time by organizing greens tools and allowing you to carry all your tools in one hand. Ergonomically shaped, features individual compartments for organizing tools, includes hole cutter straps, water bottle, removable soil container.

1038



CUP-SAVER™

Keep your cups looking white and vibrant all year with this custom tool designed to perfectly sit inside the cup. No more dealing with rags or removing cups on a green when applying chemicals or topdressing. Simply drop the Cup-Saver into the cup for maximum protection against your daily task.

- Made of durable molded plastic for increased life
- Interior handle allows easy grip for placement in cup and removal
- Never again deal with unsightly chemicals staining your cups
- Recommended to be used in conjunction with the 360° Hole Painter to prevent paint buildup on cups



CUP-SAVER

1073 Set of 5

Key Feature

Multi-use tool to keep cups bright white and extend their life.

Before topdressing

Painting cups

Applying chemicals

Make every round feel like a tour event.

The 360° Hole Painter will not only improve golfers putting visibility, but more importantly elevate the premium experience of your course with a tour-level enhancement that is easily applied in just a few minutes.

360° HOLE PAINTER

- Using a unique nozzle, effortlessly paint the top 1 in. (3 cm) above the cup bright white
- Simple and easy to use
- No "shadowing" of the paint
- No dripping on the cup or overspray on the green
- Provides a consistent, professional finish every time
- Greatly increases visibility of the cup



[View product demo at ParAide.com](https://www.paraide.com)

PATENTED

360° HOLE PAINTER

Case of 12, 12 oz. cans
910 360° Hole Paint*

Includes 3 aluminum cup shields
911 360° Painting Tool

REPLACEMENT SHIELDS

911-1 3 Aluminum

911-2 10 Plastic



*Note – ground shipping only.





BUNKER RAKES

ESTD



1955

ACCUFORM™ ACE II BUNKER RAKE

Smoothing out bunkers with our ultra-lightweight design has made this rake better than ever before. And it shows.

- Ends are tapered to reduce unsightly furrows left by rakes with straight ends
- Available in 17 in. and 25 in. (43 cm and 64 cm) heads
- Impact-resistant, high-density poly – superior Accuform quality
- Each pass of the rake blends with the pass before and after



PA Par Aide Exclusive

The most trusted bunker rake for tournaments worldwide with a patented design to reduce furrows.

ACCUFORM™ ACE II – 17 IN. (43 CM)

- Heads and handles shipped in separate cartons
- All rake handles include grips

17 in. Accuform Ace II with 54 in. Rake Handle

Boxes of 25 – Best Value

990-125 Hunter Green Honeycomb Handle

990-525 Hunter Green Aluminum Handle

990-825 Hunter Green ProTect™ Handle

990-1025 Sienna Brown Aluminum Handle

17 in. Accuform Ace II with 72 in. Rake Handle

Boxes of 25 – Best Value

990-925 Hunter Green ProTect™ Handle



Pair your Accuform Ace II with splinter free ProTect™ handle for the ultimate performing bunker rake.

 [View product demo at ParAide.com](https://www.paraide.com)



Individual rakes are available for an additional cost.



 **ACCUFORM™ ACE II – 25 IN. (64 CM)**

- Heads and handles shipped in separate cartons
- All rake handles include grips

25 in. Accuform Ace II with 54 in. Rake Handle

Boxes of 25 – Best Value

995-125 Hunter Green Honeycomb Handle

995-525 Hunter Green Aluminum Handle

995-825 Hunter Green ProTect™ Handle

995-1025 Sienna Brown Aluminum Handle

25 in. Accuform Ace II with 72 in. Rake Handle

Boxes of 25 – Best Value

995-925 Hunter Green ProTect™ Handle

Individual rakes are available for an additional cost.



ACCUFORM™ ACCUCURV™ BUNKER RAKE

Our easy-to-use Accuform AccuCurv Bunker Rake combines a patented two-sided profile with the lightweight feel of the Ace II Bunker Rake. The AccuCurv Bunker Rake is value-priced and offers unmatched durability.



ACCUFORM™ ACCUCURV – 15 IN. (38 CM)

- Heads and handles shipped in separate cartons
- All rake handles include grips

Accuform AccuCurv with 54 in. Rake Handle

Boxes of 25 – Best Value

997-125 Hunter Green Honeycomb Handle

997-525 Hunter Green Aluminum Handle

997-825 Hunter Green ProTect™ Handle

997-1025 Brown Aluminum Handle

Accuform AccuCurv with 72 in. Rake Handle

Boxes of 25 – Best Value

997-925 Hunter Green ProTect™ Handle

Key Feature

Lightweight and value-priced.



Individual rakes are available for an additional cost.

ACCUFORM™ DEEP FACE BUNKER RAKE

The extra-long 8 ft. (2.4 m) handle on this rake is perfect for large, deep face bunkers, as it eliminates the need to enter the bunker to perform maintenance. Use this rake to vary your location when raking bunkers to eliminate wear patterns on bunker edges. The long handle, coupled with a 25 in. (64 cm) Accuform Ace II rake head, makes this the ultimate rake for maintaining your bunkers.

995-7



Par Aide Exclusive

Extra long reach for raking steep bunker faces.

ACCUFORM™ GOLF CART BUNKER RAKES

- Our popular Accuform bunker rakes are now available in a convenient length to fit most golf carts
- The 48 in. (1.2 m) Hunter Green aluminum handles are available for both the 17 in. (43 cm) Ace II and 15 in. (38 cm) AccuCurv heads
- All handles are supplied without a grip to allow the bunker rake to be easily removed and replaced in the golf cart rake holder



Individual rakes are available for an additional cost.

ACCUFORM™ GOLF CART BUNKER RAKES

Accuform Ace II – 17 in. (43 cm) with 48 in. Green Aluminum Handle

Boxes of 25 – Best Value
990-225 Hunter Green Aluminum Handle

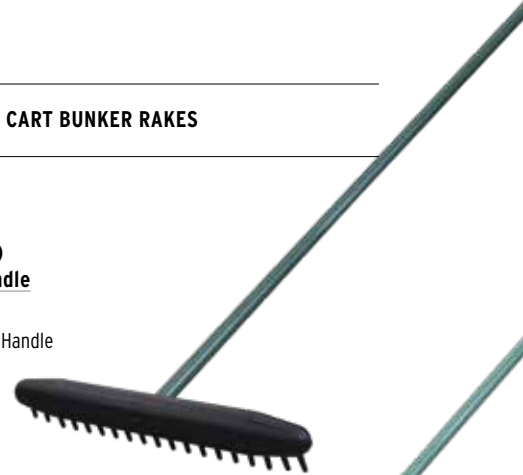

Accuform AccuCurv – 15 in. (38 cm) with 48 in. Green Aluminum Handle

Boxes of 25 – Best Value
997-225 Hunter Green Aluminum Handle



48 in. Green Aluminum Handle, Replacement

972-2 Replacement Handle



No grip allows for easy insertion and removal from golf cart rake holder.

NEW MAINTENANCE RAKE

- Single pass efficiency will save your back
- Ideal maintenance rake for removing debris from bunkers
- Torsion spring tines leave sand in place while clearing refuse
- Perfect for working with leaves, mulch, pine needles, in flower beds and more

555935 21 in. (53 cm) head with 54 in. (1.4 m) handle



PROTECT™ IS THE NO. 1 RAKE HANDLE IN GOLF

The ProTect bunker rake handle features:

- Strength you'd expect from traditional fiberglass handles
- Long-lasting thermoplastic coating that dramatically reduces the chance of fiberglass splinters
- Fibers that will stay enclosed in any weather condition
- High-quality UV coating keeps the rake handle flexible and fade resistant
- Fits any Par Aide rake head (see below for all options)

So get a better grip on your bunker maintenance. Get your hands on the ProTect rake handle.

BUNKER RAKE HANDLES, HANDLE DECALS AND GRIPS

972-8 54 in. (1.4 m) Hunter Green ProTect (thermoplastic coated) Handle

972-9 72 in. (1.8 m) Hunter Green ProTect (thermoplastic coated) Handle

972-1 54 in. (1.4 m) Hunter Green Honeycomb Fiberglass Handle with Rubber Grip

972 54 in. (1.4 m) Hunter Green Powder-coated Aluminum Handle

972-10 54 in. (1.4 m) Sienna Brown Powder-coated Aluminum Handle

972-2 48 in. (1.2 m) Hunter Green Aluminum Handle - No Grip

965-1 "Leave Rakes In Bunkers" Handle Decal, sold in sets of 13 (Not shown)

965-2 "Leave Rakes Out of Bunkers" Handle Decal, sold in sets of 13 (Not shown)

974-10 Rubber Grips, sold in sets of 10 (Not shown)

PROTECT™ GRIP

Par Aide's ProTect Grip is the safest way to have bunker rakes on the course while reducing touchpoints from all golfers! These grips are designed to be used by individual golfers, include a clip to attach to a golf bag, push cart or golf car, and they couldn't be easier to use! Simply slide the ProTect Grip over the bunker rake grip, rake bunker, remove ProTect Grip and clip back on bag/cart/car.

- Designed to be used by individual golfers
- Includes clip for golf bags or carts
- Allows bunker rakes to be placed back on golf courses
- Strong, durable and weather resistant material
- Easy to sanitize between uses
- Sold in sets of 10 grips

975-10 ProTect Grips, sold in sets of 10

 [View product demo at ParAide.com](https://www.ParAide.com)

PA Par Aide Exclusive

ProTect™ handle eliminates splinters.

Thermoplastic coating drastically reduces the chance of fiberglass splinters.

Fiberglass core for superior strength



Fiberglass Honeycomb Handle

- Fiberglass honeycomb handle offers greater strength
- Fiberglass handles contain improved UV protection to maximize handle life



Powder-coated Aluminum Handle

- Available in Sienna Brown or Hunter Green
- Powder-coated aluminum for a non-fiberglass option. Lightweight yet strong





MAINTENANCE TOOLS

ESTD



1955

ACCUFORM™ Par Aide is committed to providing only the highest-quality products to our customers. To uphold this strong commitment we offer Accuform® maintenance rakes – a brand that definitely complements our superior quality.

PA Par Aide Exclusive

Patented design allows rake head to float across sand.



ACCUFORM™ ACCUSMOOTH™ MAINTENANCE BUNKER RAKE

A patented original that rakes and smooths.

13130 22 in. (56 cm) head with 66 in. (1.7 m) Orange Powder-coated Aluminum Handle

13134 22 in. (56 cm) head with 82 in. (2.1 m) Orange Powder-coated Aluminum Handle



ACCUFORM™ SPRING BRACE LEAF/GROOMING RAKE

Heavy-duty spring action, 24 steel tines, and a bolted-through, head-to-handle connection.

13160 24 in. (61 cm) head with 54 in. (1.5 m) Orange Powder-coated Aluminum Handle



ACCUFORM™ LANDSCAPE RAKE

Long rounded teeth for smooth, non-gouging raking action and a large striking edge excellent for grading.

13110 24 in. (61 cm) head with 66 in. (1.7 m) Orange Powder-coated Aluminum Handle

13114 36 in. (91 cm) head with 66 in. (1.7 m) Orange Powder-coated Aluminum Handle

13118 48 in. (122 cm) head with 66 in. (1.7 m) Orange Powder-coated Aluminum Handle



ACCUFORM™ SCREENING RAKE

Designed for sifting, grading and screening stones and debris from sand or fine soil.

13120 24 in. (61 cm) head with 66 in. (1.7 m) Orange Powder-coated Aluminum Handle

13124 36 in. (91 cm) head with 66 in. (1.7 m) Orange Powder-coated Aluminum Handle

ACCUFORM™ Tending to the turf has never been easier than with these specialty tools from Accuform by Par Aide. Each is specially designed to make caring for turf easier, and with our sturdy construction, they will stand up to daily use for years.



ACCUFORM™ PLUG PUSHER

The specially designed 36 in. (91 cm) aluminum head is excellent for pushing aeration plugs off the green. Comes with sturdy wrap-around bracing and a 66 in. (1.7 m) orange powder-coated aluminum handle with a 5 in. (13 cm) vinyl grip.

13240 36 in. (91 cm) head with 66 in. (1.7 m) Orange Powder-coated Aluminum Handle



ACCUFORM™ ACCULEVEL

From spreading to smoothing, or breaking up soil before seeding or planting, the AccuLevel is perfect for soil preparation projects of all kinds. It offers the perfect size head: 34 in. x 10 in. (86 cm x 25 cm) plated steel. It's also easier to use because it features a lightweight, sturdy 72-in. (1.82 m) aluminum handle, not a heavy wooden handle used on competitive models.

13265 34 in. (86 cm) head with 72 in. (1.82 m) Orange Powder-coated Aluminum Handle

 [View product demo at ParAide.com](http://ParAide.com)

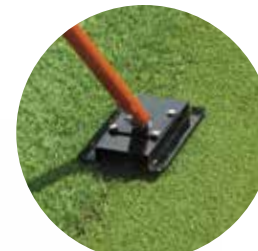

Par Aide Exclusive

Prevent unwanted turf varieties from creeping into green surface.

ACCUFORM™ GREEN EDGER

Just walk the Green Edger around the greens; it slides easily, cutting troublesome "runners" to keep greens and surrounds perfect looking all year. Create definition between greens and surrounds and prevent different turf types from migrating and blending together – all without unsightly gouges. Cuts 1 1/2 in. below turf.

13260 Accuform Green Edger

13261 3 Pack of Replacement Blades



ACCUFORM™ ROLLER SQUEEGEE

Recommended for removing water from greens and turf, this non-absorbent squeegee features a heavy-duty-ribbed frame, combined with wraparound bracing to eliminate deflection when pressure is applied, has a 60 in. (1.5 m) bent handle in orange powder coat and vinyl grip.

13220 24 in. (61 cm) Squeegee head with 60 in. (1.5 m) bent Orange Powder-coated Aluminum Handle

13224 36 in. (91 cm) Squeegee head with 60 in. (1.5 m) bent Orange Powder-coated Aluminum Handle

ACCUFORM™ STAR SPIKER

Heavy-duty 12 in. (31 cm) steel head, with 18 stainless steel star spikes, penetrates soil deeper. Ergonomically bent 54 in. (1.4 m) aluminum handle. Excellent for scarifying greens, breaking up algae, overseeding and providing best seed-to-soil contact.



13256 12 in. (31 cm) Star Spiker with 54 in. (1.4 m) bent Orange Powder-coated Aluminum Handle



ACCUFORM™ BALL MARK PLUGGER

This tool helps you remove ball marks on greens quickly and easily. Works great to remove Poa Annua and goosegrass, too. The Ball Mark Plugger removes plugs 1 ½ in. (4 cm) by 2 ½ in. (6 cm) deep and comes with 3 ¾ in. (8 cm) rubber washers for shallow plug extraction. The hollow handle holds up to 12 plugs. 31 in. (79 cm) Tall

1094



ACCUFORM™ TURF PLUGGER

This handy tool allows you to easily replace worn, damaged areas with healthy turf. Use it on greens, tees, fairways and ends of cart paths. Also good for weed removal. Removes turf plugs 2 ¾ in. (6 cm) wide by 2 ½ in. (6 cm) deep, the ideal size for regrowing turfgrass. Features a replaceable cutter blade made from case-hardened steel, and a hollow handle that can hold up to 12 plugs. 31 ½ in. (80 cm) Tall

1095

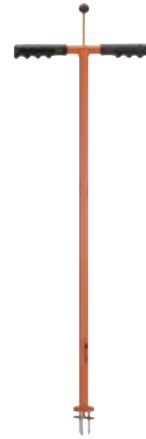

ACCUFORM™ WEED PULLER

Weed removal is easier with the Accuform Weed Puller. It removes the weed and the entire root system to prevent regrowth. Simply center the three spikes on the weed, twist and remove with spring-loaded plunger. Made of steel tubing, with replaceable steel spikes that can be positioned different ways to adjust for small and large weeds. Upright handle allows you to weed without bending. Works great on crabgrass, goosegrass, dandelions and all bunch-type weeds and grasses. 41 in. (104 cm) Tall

1150



ACCUFORM™ SOIL PROFILE SAMPLER

This exclusive Mascaro design makes extracting soil samples easier than ever. Our Profile Sampler gives you an undisturbed soil profile 6 in. (15 cm) deep, 3 in. (8 cm) wide and ½ in. (1 cm) thick. Hinge design allows you to easily view the root zone and thatch clearly, with no bolts or screws to get in the way. The innovative design not only keeps the blades from separating when inserted into the turf, but also makes it easier to replace the sample after viewing. 25 ½ in. (65 cm) Tall

1130



Key Feature

Hinge design for easy profile viewing. Tapered design prevents blades from separating.

[View turf tool demos at ParAide.com](http://ParAide.com)

ACCUFORM™ When a turf tool bears the Accuform name, you can be sure it helps the Superintendent and crew work more quickly and effectively. You can also be sure it offers superior functionality, performance and durability. Our Accuform tools improve course conditions in a way only Par Aide products can.

ACCUFORM™ ACCUSEED™

The Accuform AccuSeed is the perfect spot seeding tool. The specially designed stainless steel spring loaded spikes puncture the turf $\frac{5}{16}$ in. deep while dropping bent grass seed precisely into the holes, allowing for ideal seed to soil contact. Grass seed is easily filled into the black housing and is only released when the spring-loaded head compresses. There is minimal impact to the surface, due to the flat surface of the seed housing, which causes little disruption to play. 43 in. tall (109 cm)

13270



PA Par Aide Exclusive
Punch holes and drop seed all in one motion.

▶ View product demo at ParAide.com



Seed filled spikes extended.



Spikes retracted, leaving seed in holes.



AccuSeed provides quick results.

ACCUFIX™ ACCUFIX™

This affordable, light, easy-handling tool is designed to effectively repair ball marks in one motion. The rounded handle and rubber grip are comfortable to use with one hand. Simply push down over the ball mark and the spring-loaded head with stainless steel teeth will lift the turf back into a perfect playing surface.

Features include:

- 36 in. (91 cm) powder-coated aluminum handle
- Stainless steel teeth
- Spring loaded head
- Ergonomic handle
- Rubber grip

1092 Accufix

Accufix Repair Kit

1092-99 Includes 4 replacement teeth, links and hardware

Key Feature

Open mechanism allows for easy cleaning and lubrication.



NEW MILTONA LEVEL BEST™ BALL MARK REPAIR TOOL

- Truly mimics the proper ball mark repair action
- Designed to restore the original putting surface
- Bulletproof construction features stainless steel teeth, machined aluminum parts and a brass bushing
- Outfit your crew, rangers and marshals with the best – the Level Best

550646 Level Best Ball Mark Repair Tool

550647 Replacement Stainless Steel Teeth



NEW

MILTONA QUICK-FILL BALL MARK ERASER

- Improve the appearance of greens damaged from ball marks
- Erase ball marks instantly with a dash of green sand
- Innovative design means one touch dispenses perfect amount of sand
- No bending over, no getting down on your knees and no jamming
- Replaces “ketchup” bottle and other less effective tools

550650 Quick-Fill Ball Mark Eraser

PA Par Aide Exclusive

▶ View product demo at ParAide.com



NEW

MILTONA GREENS BULLET

- Lightweight yet durable stainless construction
- Adjustable collar so you can reach your desired depth
- Use with Quick-Fill for best results

550655 Greens Bullet



NEW MILTONA GROUND ZERO II

- Indispensable tool for leveling and holding irrigation heads and valve boxes
- Ideal device for golf course, sports field or other grounds area irrigation projects
- Convenient folding design makes it easy to use, carry and store
- Use for initial installation or resetting
- 54 in. (137 cm) steel arms are virtually indestructible

525540 Ground Zero II

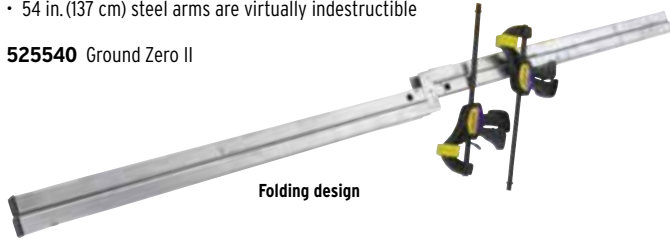

PA Par Aide Exclusive

NEW MILTONA QUICKCUT™ IRRIGATION HEAD TRIMMER

- Quickly trim any size irrigation head
- Spring steel blades adjust in ½ in. (1 cm) increments
- Short blades adjust from 6 in. to 8 in. (15 cm to 20 cm) diameter
- Long blades adjust from 8 in. to 10 ½ in. (20 cm to 27 cm) diameter
- Two sizes, pre-assembled in a fixed shape
- Easy to assemble, hardware included
- Simple to step into well-watered turf
- Sturdy all-steel frame
- Also trims distance markers

530545 Trimmer with 7 in. (18 cm) Fixed Blade

530546 Trimmer with 7 ½ in. (19 cm) Fixed Blade

530547 Trimmer with Short Adjustable Serrated Blade

530548 Trimmer with Long Adjustable Serrated Blade

Quickcut Trimmer Handle

530542 Handle only

Replacement Blades

530550 7 in. (18 cm) Fixed Blade

530551 7 ½ in. (19 cm) Fixed Blade

530552 Short Adjustable Serrated Blade

530553 Long Adjustable Serrated Blade



[View product demo at ParAide.com](#)



IRRIGATION SYSTEM REFERENCE

6 in. (15 cm)	Toro 760
6 ½ in. (17 cm)	Hunter/Legacy 520/550/600/650
7 in. (18 cm)	Toro 630/730
7 ½ in. (19 cm)	Toro 650/655/670/750/780
10 in. (25 cm)	Toro 690/Rainbird 91 DR/91 DS
10 in. (25 cm)	Rainbird 900/950

CORE HOG®

This tool dramatically cuts aeration time and offers the most streamlined way to clean cores from greens. Just walk a straight line through your green as it plows all cores in its path into a neat pile right off the green. Then shovel it up and move on to the next green. The Core Hog easily mounts to walk-behind greens mowers with brackets compatible with Toro® 1000, Toro® Flex 21, Jacobsen® PGM and John Deere® 220, 220A and 180A.

- Up to 70% faster than manual cleanup
- Provides safe green contact with smooth plastic wear bars
- Stainless steel hardware designed for long-lasting wear
- Made of powder-coated 10-gauge steel
- Replacement bracket sets available



CORE HOG WITH UNIVERSAL BRACKET

1075



CORE HOG WITH TORO FLEX 21 BRACKET

1076



PA Par Aide Exclusive
Core Hog® pays for itself in one use.

Toro is a registered trademark of Toro, Inc.; Jacobsen is a registered trademark of Textron, Inc.; John Deere is a registered trademark of Deere, Inc.

AERIFYING AND TOPDRESSING CUP PLUGS

Protect the integrity of the hole when aerifying or prevent sand from filling up cup hole when topdressing.

- Durable lightweight, weather-resistant foam material
- Can be left in holes during winter months
- Aerification tines can penetrate plug without removing it from the hole
- Can be reused 2-3 times
- Sold in sets of 9

1070 Regulation Cup Size

1071 Practice Cup Size



Hole after aerifying using Cup Plug.



Hole after aerifying without Cup Plug.

PA Par Aide Exclusive
Cup Plug protects hole from damage when aerating.

▶ View product demo at ParAide.com

CORE BUSTER®

Our innovative Core Buster Drag Mat breaks up cores easier, faster, better. Made of durable polyethylene, it's safer on your turf than steel mats. The interlocking 20 in. x 20 in. x 2 in. (51 cm x 51 cm x 5 cm) grid panels let you create a variety of sizes, so you can add or subtract to fit your fairways, tees and greens. Plus, the Core Buster is durable and rust-free, and the panels are stackable or can be hung for easy storage. Also works great for breaking up grass clippings, dragging in topdressing on greens and working in seed when overseeding. Easily handled by one person.

 [View product demo at ParAide.com](#)



CORE BUSTER DRAG MAT I

Includes 24 panels, draw bar and all hardware.

1081 160 in. x 60 in. (406 cm x 152 cm)
(8 panel x 3 panel)



INDIVIDUAL PANEL

20 in. x 20 in. (51 cm x 51 cm)

1080-10

HARDWARE KIT (Not shown)

Includes 4 eye bolts with washers and nuts, and 4 quick clips.

1080-11

CORE BUSTER DRAG MAT II

Includes 15 panels, draw bar and all hardware.

1080 100 in. x 60 in. (254 cm x 152 cm)
(5 panel x 3 panel)



DRAW BARS

Made from galvanized steel for added strength.

1080-12 Single Section Only, Complete

PA Par Aide Exclusive

Much larger mat that only requires one person to operate.



Key Feature

Unique design breaks up cores more completely than steel mats.



How to expand the Core Buster Drag Mat

To add an additional vertical row:
Order one draw bar, one hardware kit and three individual panels.

To add an additional horizontal row:
Order five or eight individual panels. No hardware or bars needed.



THE SUPERINTENDENT WHITEBOARD SYSTEM

The Superintendent Whiteboard System, is another innovation from Par Aide. Built directly with input from Superintendents, our whiteboards save you time, provide better flexibility and make daily communication with your crew more efficient than with homemade boards.

Board Features:

- 2 x 4 ft. individually framed, pre-printed whiteboard panels
- High-quality whiteboard material
- Mounting hardware included
- Available in both regular and magnetic materials
- Mix and match to create the best whiteboard for your needs
- Panels are simply placed next to each other and attached to wall
- Artwork is printed on panels, then covered with a dry-erase material – printing won't rub off

NON-MAGNETIZED WHITEBOARD

See below for individual part numbers.

MAGNETIZED WHITEBOARD

See below for individual part numbers.

Go to ParAide.com to see popular board combinations and whiteboard accessories.

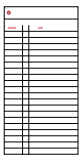

Job Board (1 Job)
7250-01 Non-magnetized
7251-01 Magnetized

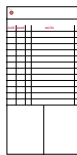

Mechanics Board
7250-07 Non-magnetized

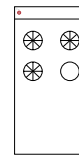

Mowing Patterns
7251-10 Magnetized

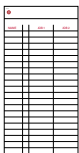

Job Board (2 Jobs)
7250-02 Non-magnetized
7251-02 Magnetized



Blank Board
7250-08 Non-magnetized

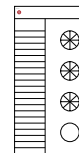

Mowing Patterns and Job Extension Board
7250-11 Non-magnetized
7251-11 Magnetized

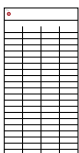

Job Board (Days of the Week)
7250-03 Non-magnetized
7251-03 Magnetized



Lined Board
7250-09 Non-magnetized
7251-09 Magnetized



Misc. Notes Board
7250-12 Non-magnetized
7251-12 Magnetized

PADDED WORK GLOVES

These affordable gloves offer a great fit, a great feel and tremendous protection. A padded foam rubber palm helps with vibration dampening.

- 13594-01 Medium
- 13594-02 Large
- 13594-03 Extra Large



Key Feature

Works with touchscreens.



SAFETY NET

The 6½ ft. x 6 ft. (2 m x 1.8 m) net provides ample protection for employees doing work in the line of fire. Its collapsible frame has aluminum uprights with fiberglass upper and lower cross pieces and heavy-duty "step-in" stakes that secure the uprights. The net is high-strength poly with high-visibility safety yellow borders. Literally sets up in seconds!

1100

Par Aide Exclusive

Safety in seconds... a must for any golf course.





E-Z WHIPPING POLE

- Lightweight, durable whipping pole for removing dew and worm casts from greens
- E-Z whipping pole has a durable, 8 ft. (2.4 m) tapered fiberglass tip
- E-Z whipping pole offers two-piece design, with a lightweight anodized aluminum handle
- On our E-Z Whip™ design, the fiberglass tip slides inside the handle during storage and transportation and easily extends out for whipping

1060 E-Z Whipping Pole

E-Z Whip Whipping Pole Parts (Not shown)

1065 Fiberglass Tip

1066 Handle with Hand Grip

 [View product demo at ParAide.com](https://www.ParAide.com)



Fiberglass tip slides in and out of handle (cut-away view)

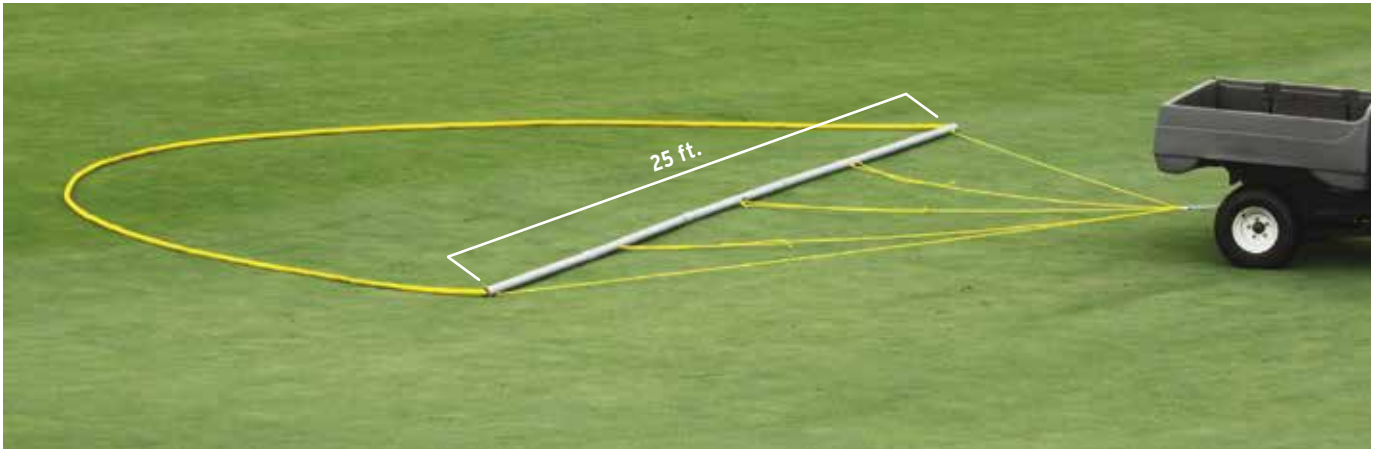

NEW DEW DRAGGIN'

The Dew Draggin' fine-tunes your course for events and early morning golfers by removing dew and dispersing grass cuttings, all while reducing labor, money and time! Dew removal is also proven to be one of the best ways to help reduce turf disease. An average-sized, 18-hole course can be covered in just 60-90 minutes. The rugged 1 ½ in. (3 cm) polypropylene drag rope follows ground contours and the drag harness attaches to any maintenance vehicle. Harness lines let the 25 ft. (7.6 m) wide Dew Draggin' maneuver around obstacles and provide dramatically improved results after mowing. And at just 30 lb (13.6 kg), the Dew Draggin' can easily be pulled by hand over delicate greens.

555690 Dew Draggin'

555691 Dew Draggin' Handle Attachment

 [View product demo at ParAide.com](https://www.paraide.com)

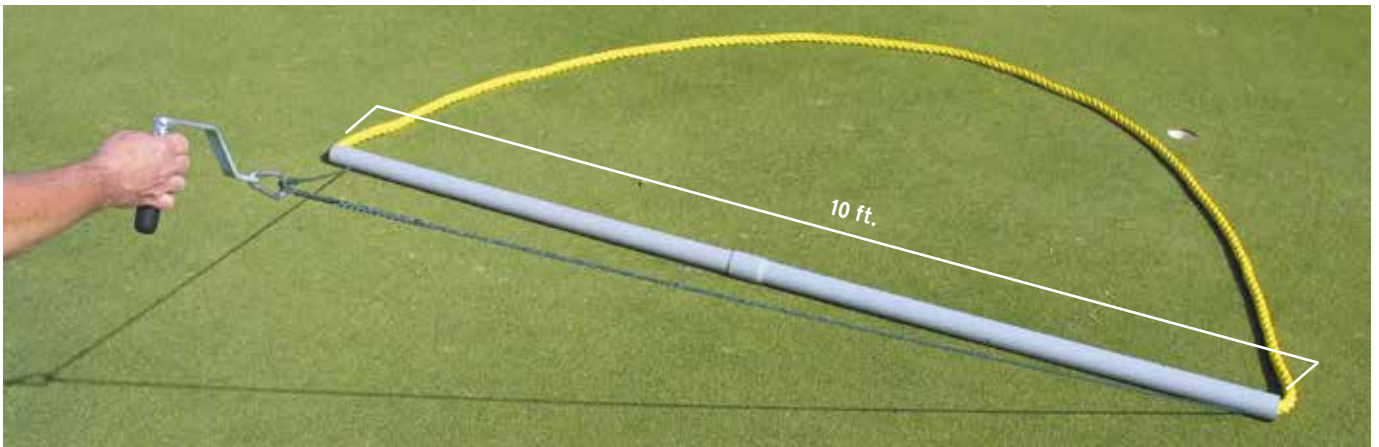

NEW GREEN DRAGGIN'

- Like the original Dew Draggin' (above), this smaller version is the ideal tool for dew removal
- The 10 ft. (3 m) wide, hand-held Green Draggin' effectively knocks down dew from the green
- Customize your Green Draggin' by creating a harness to attach to the back of greens mowers
- 1 ½ in. (3 cm) braided polypropylene rope

555694 Green Draggin'



 MILTONA

TURF REPAIR TOOLS

ESTD



1955

MILTONA THE ORIGINAL HEX-PLUGGER™

- Eliminates the gaps that occur when using hole cutters or round pluggers
- Hexagon-shaped plugs create a “locking” effect and prevent shifting
- All models include trowel to maintain uniform plug depth
- Available in three different models for all your turf-mending needs
- Ideal for replacing damaged cups
- Solid steel construction

 [View product demo at ParAide.com](#)



TECH TIP

Use the model 510218 Miltona Sod Stripper™ with its 2 in. (5 cm) deep cut blade for projects requiring a large number of plugs.

- First use the Sod Stripper to undercut the root mass of your nursery green turf
- Next use the model 502107 Hex-Plugger to remove 2 in. (5 cm) plugs from the undercut area

This will save time by eliminating the need to trowel cut each plug.



Turf repaired with Miltona Hex-Plugger



Bonus: Trowel included for uniform plug depth

NEW

MILTONA HEX-PLUGGERS – 5 IN. & 7 IN. (13 CM & 18 CM)



502105 5 in. (13 cm) Hex-Plugger,
Cuts 2 in. (5 cm) Deep Plug



502107 7 in. (18 cm) Hex-Plugger,
Cuts 2 in. (5 cm) Deep Plug



502108 7 in. (18 cm) Hex-Plugger,
Cuts 3 in. (8 cm) Deep Plug



PA Par Aide Exclusive

NEW MILTONA SQUARE PLUGGER – 7 IN. (18 CM)

- Use Square Plugger when straight edge repairs are preferred
- Allows for stacking plugs as you make repairs

501104 7 in. (18 cm) Square Plugger,
Cuts 3 in. (8 cm) Deep Plug

NEW MILTONA ADJUSTABLE DEPTH HEX-PLUGGER – 9 IN. (23 CM)

- Adjust plug cutting depth from 2 in. to 5 in. (5 cm to 13 cm)
- Includes hex cutting head and PowerStroke™ handle

502119 9 in. (23 cm) Adjustable Hex-Plugger,
Cuts 2 in. to 5 in. (5 cm to 13 cm) Deep Plug

 [View product demo at ParAide.com](https://www.ParAide.com)

FOR ULTIMATE TURF REPAIR COMBINE WITH THE SOD STRIPPER AND ALL OF ITS CUTTING BLADE SIZES

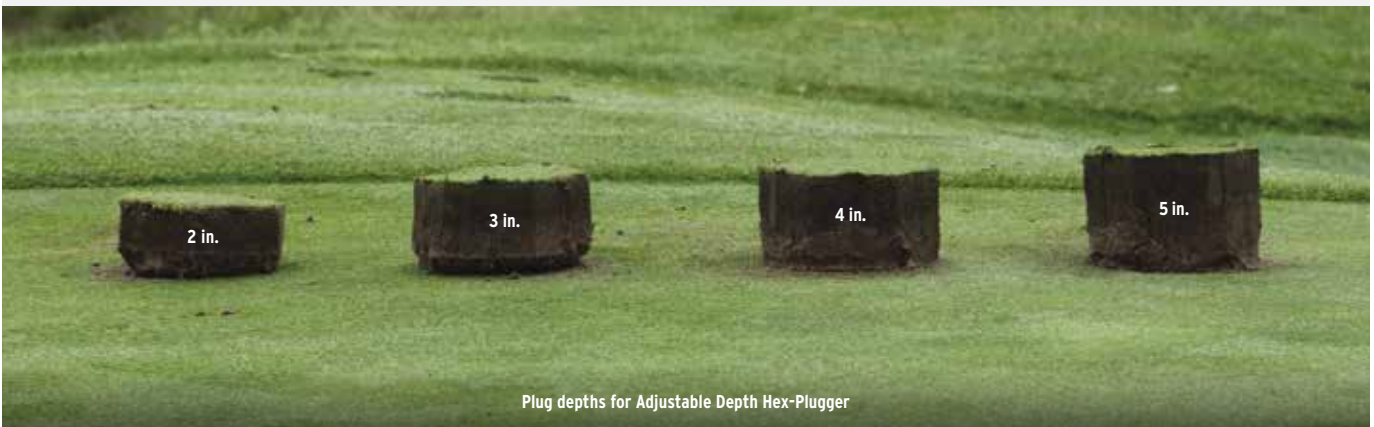

Plug depths for Adjustable Depth Hex-Plugger

NEW

MILTONA SOD STRIPPER™

- Cut a strip of sod for any turf repair
- The ULTIMATE tool for repairing hydraulic leaks or vandalism
- Solid steel construction with zinc plating
- Blade width available in 2 in., 3 in., 5 in. and 7 in. (5 cm, 8 cm, 13 cm and 18 cm)
- Depth of cut adjustable between 5/8 in. and 1 in. (2 cm and 3 cm)
- 7 in. x 2 in. (18 cm x 5 cm) deep cut blade can be used in conjunction with 7 in. x 2 in. (18 cm x 5 cm) Hex-Plugger
- Easily strips out damaged area as well as replacement turf from nursery green
- Precut strips on nursery green and then use Hex-Plugger to cut replacement plugs
- Saves time by eliminating trowel cutting of individual plugs
- Ensures consistent depth of hex plug

510220 Sod Stripper Combo with 2 in., 3 in., 5 in. and 7 in. (5 cm, 8 cm, 13 cm and 18 cm) Blades

Best Value

510221 Sod Stripper Combo with 4 Blades plus 7 in. x 2 in. (18 cm x 5 cm) Deep Cut Blade

Best Value

510212 Sod Stripper with 2 in. (5 cm) Blade

510213 Sod Stripper with 3 in. (8 cm) Blade

510215 Sod Stripper with 5 in. (13 cm) Blade

510217 Sod Stripper with 7 in. (18 cm) Blade

Replacement Blades

510222 2 in. (5 cm) Blade

510223 3 in. (8 cm) Blade

510225 5 in. (13 cm) Blade

510227 7 in. (18 cm) Blade

510218 Sod Stripper with 7 in. x 2 in. (18 cm x 5 cm) Deep Cut Blade

510228 7 in. x 2 in. (18 cm x 5 cm) Deep Cut Blade

PA Par Aide Exclusive



Hydraulic oil leak or vandalism

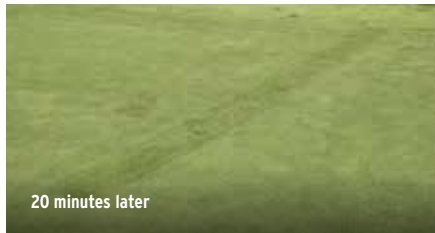

20 minutes later

[View product demo at ParAide.com](#)



Combine with a Hex Or Square Plugger for the ultimate in turf repair



NEW MILTONA QUICK SEED™

- Designed with flat ends (not sharpened) to push seed into contact with soil
- Competitive models with sharpened spikes go around the seed, leaving most above the soil
- All-steel construction with bent handle to increase leverage and improve penetration
- Can be used to easily break up algae mat

543564 13 in. (33 cm) Quick Seed

PA Par Aide Exclusive



 [View product demo at ParAide.com](#)

NEW MILTONA SPOT OVERSEEDER-SPIKER

- Perfect tool to prepare mid-sized areas for overseeding
- 100 square feet can be prepared in less than 20 minutes
- The 8 in. x 11 in. (20 cm x 28 cm) spike pad features 72, ¼ in. (1 cm) diameter spikes, spaced 1 in. (3 cm) on center
- Spring-operated ejection pad prevents tearing or lifting of turf
- To use, simply step or jump on pad to force spikes ½ in. to ¾ in. (1 cm to 2 cm) into ground
- All-steel construction will stand up to the most intense overseeding projects

540560 Spot Overseeder-Spiker



PA Par Aide Exclusive



Combine with the Quick Seed to make spot seeding a breeze

 [View product demo at ParAide.com](#)

NEW

MILTONA JOBSAVER™

- Time and again it earns its name – saving jobs by saving greens
- Overseeding greens becomes easier than ever with our exclusive attachments for your power aerifier
- Precision-crafted to perform at peak operating levels
- Spring-action stripper plates prevent tearing or lifting of turf
- The ¼ in. (1 cm) diameter Jobsaver spikes create the perfect seed bed, yet allow areas to be kept in play
- Keeps greens in play during seeding process

PA Par Aide Exclusive



▶ View product demo at ParAide.com

546571 Toro ProCore 648 – Spikes spaced 1¼ in. (3 cm) on center, 72 holes per stroke (Set of 6)



Shown on Toro ProCore 648

546569 John Deere 800 – Spikes spaced 1¼ in. (3 cm) on center, 48 holes per stroke (Set of 4)

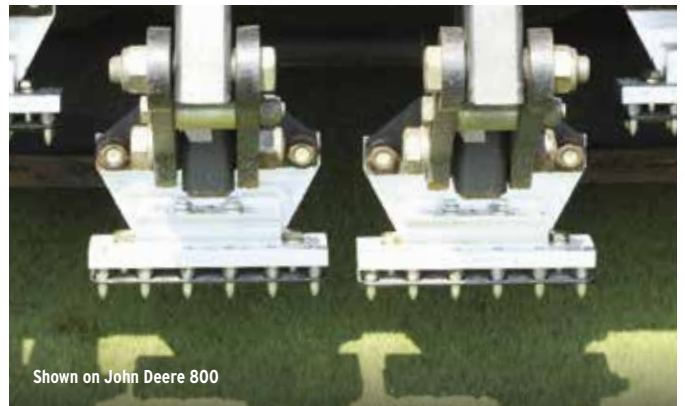

Shown on John Deere 800

JOBSAVER™ REPLACEMENT BUSHINGS

- Jobsaver bushings are designed to wear to prevent permanent damage to Jobsaver heads
- Keep extra replacement bushings on hand so they are available when needed
- Check bushings regularly and replace when worn
- Universal bushings fit both Jobsaver models

546567-22 Jobsaver Replacement Bushings (Set of 2)



NEW MILTONA PLUG STACKER™

- Cut and stack 2 in. (5 cm) deep plugs
- Holds up to 12 plugs
- Solid steel construction with hardened blade to maintain sharpness and durability
- Also great for re-establishing turf species from plug
- Available in 2 in. and 3 in. (5 cm and 8 cm) diameter models

500102 2 in. (5 cm) Plug Stacker

500103 3 in. (8 cm) Plug Stacker



 [View product demo at ParAide.com](https://www.paraide.com)

NEW MILTONA TURFJECTOR™

- Your solution for dry spots
- Includes ball valve to control water flow
- Inject water, wetting agents and other liquids into localized dry spots
- Features four stainless steel injector tines that penetrate 2 in. (5 cm) deep

525570 Turfjector

525571 Replacement Tine



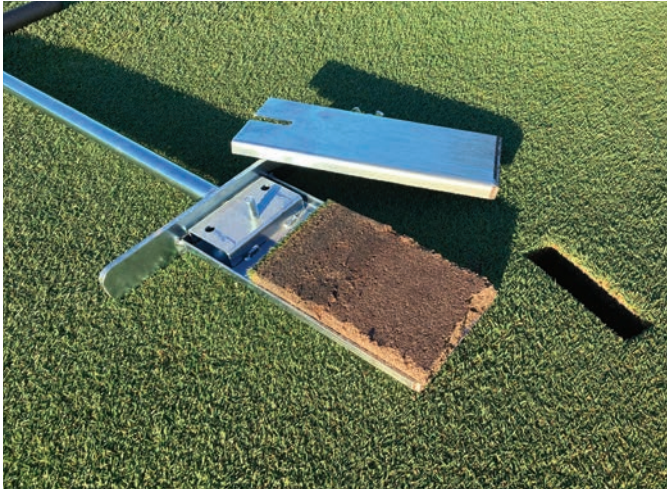

NEW  **MILTONA SOIL PROFILER**

- Study your greens soil profile
- Provides a 1 in. (3 cm) thick by 4 in. (10 cm) wide soil sample up to 7 in. (18 cm) deep
- Removable plate allows for easy access to profile sample

520520 Soil Profiler



NEW  **MILTONA SOIL PROBE**

- Great for soil sample testing
- Takes up to a 15 in. (38 cm) sample core
- Features a replaceable 3/4 in. (2 cm) cutting tip

520515 Soil Sampling Probe

520516 Extra Probe Tip

 **Key Feature**

Extra tall 19 in. (48 cm) probe for easy use and greater visibility.

NEW  **MILTONA HANDI-AERIFIER™**

- Seven 1/2 in. (1 cm) diameter tines
- Fix localized dry spots
- Eliminate high spots
- Cores are collected in the cylinder
- Lower a sharp crown on a green
- The tines are easily removed without pulling or tearing turf

515500 Handi-Aerifier with PowerStroke™ Handle

515501 Handi-Aerifier Head Only



NEW  **MILTONA AERIFIER / SOIL SAMPLER**

- Cup changer's helper
- Use when changing cups to help prevent scalping high plugs
- Multi-use tool for taking numerous soil samples or aerifying localized dry spots
- Includes interchangeable 1/2 in. and 3/8 in. (1 cm and 2 cm) tines

520512 Aerifier, 30 in. (76 cm) handle





WHEREVER GOLF IS PLAYED®

Par Aide Products Co.

5820 Centerville Road, Suite 200
St. Paul, Minnesota 55127
Toll Free: 1.888.893.2433
Phone: 651.429.4513
Fax: 651.429.4519
e-mail: info@paraide.com

Associate Member

Golf Course Superintendents
Association of America

Associate Member

Minnesota Golf Course
Superintendents Association

Associate Member

Canadian Golf Course
Superintendents Association

Associate Member

National Golf Course Owners Association

Charter Member

National Golf Foundation

Affiliate Member

Club Managers Association of America

Member

USGA

Proud Sponsor of:

GCSAA Legacy Scholarship
MGCSA Legacy Scholarship
Wee One Foundation



Par Aide is a registered trademark; 360° Hole Painter, AccuCurv, AccuFix, Accuform, AccuSeed, AccuSmooth, Ace II, Clock Pro, Cooler Pro, Core Buster, Core Hog, Crew Caddy, Cup-Saver, Divot Mate, Divot Pro, Dura-Flex, Ever-White, E-Z Whip, FusionCast, Gold-Colored Ferrule, Green & White, Green-Saver, HiO, Par Aide, the Par Aide logo, PinSite, ProTect, Range Pro, Safe-Tee Water, Sure Putt, Tee Pro, Trash Mate, Trash Pro, Water Pro and Wherever Golf is Played are trademarks of Par Aide Products Co. All other trademarks are the property of their respective trademark holders. Par Aide thanks the staff of Bunker Hills Golf Course, Dellwood Country Club, Midland Hills Country Club, Minneapolis Golf Club, North Oaks Golf Club, Olympic Hills Golf Club, Somerby Golf Club, Stoneridge Golf Club, Tanners Brook Golf Club, Town & Country Club, TPC Twin Cities, White Bear Yacht Club and Windsong Farm Golf Club for their assistance with the golf course photography shown in this year's catalog.

MESSAGE FROM PAR AIDE

From all of us at Par Aide we'd like to express our appreciation to you, our valued customers, for your support this past year. Like many companies, we've encountered product availability issues as a result of our global supply chain disruption. As we continue to work tirelessly to improve our supply to you, we can't thank you enough for your patience and understanding. Our employees have been incredibly loyal and have worked harder than ever to see these issues through. We look forward to helping you have a successful 2022 as the golf industry continues to experience renewed growth and interest from all of those who value the benefits of the great game of golf.



THE PAR AIDE TEAM

Mike Hilliard - President
Dan Brown - Director of Sales & Marketing
Dave Leach - Operations Manager
Scott Melling - International Sales & Marketing
Mike Doyle - Business Development & Marketing
Jacob Dixon - Business Development & Marketing

Judith Hajney - Accounts Receivable
Sue Hamann - Customer Service
Stacey Cunningham - Customer Service
Terri Momsen - Customer Service
Carolyn Bly - Customer Service
Beth Boldt - Office Administration

DISTRIBUTED BY

NOTE: ALL MEASUREMENTS ARE APPROXIMATE.
FOR PAR AIDE WARRANTY DETAILS, PLEASE VISIT
WWW.PARAIDE.COM/ABOUTPARAIDE/PRIVACYPOLICY-WARRANTY
© PAR AIDE PRODUCTS CO., 2022 | PRINTED IN USA